

Solar-supported heating networks in multi-storey residential buildings



A planning handbook with a holistic approach



AEEINTEC

Solar-supported heating networks in multi-storey residential buildings

A planning handbook with a holistic approach

Authors:

Christian Fink and Richard Riva

Arbeitsgemeinschaft ERNEUERBARE ENERGIE – Institut für Nachhaltige Technologien

www.aee.at

Published by

Title:

Solar-supported heating networks in multi-storey residential buildings

A planning handbook with a holistic approach

Authors:

Ing. Christian Fink

Ing. Richard Riva

Compiled with the support of the:

European Commission (within the framework of the OPET Building, Contract No. NNE5/2002/94, DG TREN)

Federal Ministry for Transport, Innovation and Technology

Federal Ministry for the Economy and Labour

Province of Styria (FA 6A Science and Research, A15 Residential Building Grants)

City of Vienna (MA 22 Environment)

ISBN 3-901425-11-X

1st edition: 2004

Reprinting and translation, storage on data processing equipment, also including excerpts thereof, is only permitted if the source is named and requires the express written approval of the authors.

The content of the planning handbook "Solar-supported heating networks in multi-storey residential buildings" was processed and compiled with the greatest care and according to the best of our knowledge. Neither the publishers nor the authors shall assume liability for any incorrect information or any damage which might occur as a result.

Published by:

Arbeitsgemeinschaft ERNEUERBARE ENERGIE GMBH

A-8200 Gleisdorf, Feldgasse 19, Austria

Cover photos:

Top left: S.O.L.I.D., top right: Holleis Solartechnik, bottom left: Teufel & Schwarz, bottom right: AEE INTEC

Design, Typography & Reproduction:

Steinhuber Infodesign, Graz

Printed by:

Universitätsdruckerei Klampfer, Weiz

List of Contents

2	Introduction	5
2.1	Market penetration and potential of solar thermal systems in multi-storey residential buildings	5
2.2	Innovations and the economic factor	5
2.3	Motivation for this planning handbook	6
3	A holistic approach to solar-supported energy supply systems	7
3.1	Low average collector temperatures as an energy-related success factor	8
3.2	Enhancement of the solar coverage and reduction in the auxiliary heating requirements as a result of very low heat losses in the system	9
3.3	Greatest possible comfort for users	11
3.4	Systems with the greatest possible water hygiene	11
3.5	Exploiting opportunities for reducing capital costs	12
3.6	Low operating costs for users with the greatest possible reliability of supply	13
4	Solar radiation	14
4.1	Usable radiation capacity and annual usable radiation energy	14
4.2	Distribution of solar radiation throughout one calendar year	15
5	Heating requirements in multi-storey residential buildings	16
5.1	Determining heating requirements for domestic hot water	17
5.1.1	Determining daily consumption	17
5.1.1.1	Calculation of daily consumption for multi-storey residential buildings	18
5.1.1.2	Measurement of consumption in existing buildings	19
5.1.2	Consumption profile	20
5.2	Determining heating requirements	22
6	Structural integration of solar thermal systems in multi-storey residential buildings	23

6.1	Roof integration of solar collectors	24
6.2	Collector assembly with frame structures	26
6.3	Façade integration of solar collectors	29
6.3.1	Heat and moisture transport through wall structures	30
6.3.2	Reduction of the effective U-value of the outside wall	32
6.3.3	Coloured absorber layers	32
6.4	Integration of energy storage units in buildings	33
7	System hydraulics	35
7.1	Basic information about solar-supported energy supply systems	35
7.1.1	Domestic water temperature and water hygiene – legionella bacteria	35
7.1.2	Important characteristics for solar-supported energy supply systems	36
7.1.2.1	The degree of solar coverage SD	36
7.1.2.2	The specific solar thermal yield SE	37
7.1.2.3	The annual degree of system utilisation S_{Nutz}	38
7.1.3	Low-flow systems for solar thermal facilities in multi-storey residential buildings – speed control and loading strategies	38
7.1.3.1	Low-flow vs. high-flow systems	38
7.1.3.2	Speed control of primary and secondary circuits in the solar thermal system	40
7.1.4	Collector interconnections	41
7.1.4.1	Large-area collectors	41
7.1.4.2	Efficient collector pipework	42
7.1.4.3	Expansion compensation	44
7.1.4.4	Bleeding and flushing	44
7.1.5	Stagnation behaviour of solar thermal systems	45
7.1.5.1	Processes occurring during the stagnation state	45
7.1.5.2	Influence of collector and system hydraulics on stagnation behaviour	47
7.1.5.3	Modified dimensioning of the membrane expansion tank	47
7.1.5.4	Conclusions for the design of stagnation-proof systems in multi-storey residential buildings	49

7.2	Solar-supported heat supply system designs	50
7.2.1	Solar-supported heat supply system designs based on the principle of 2-pipe networks	51
7.2.1.1	Integrating the heat generators	51
7.2.1.2	Solar-supported heat supply systems – two-pipe networks combined with decentralised apartment units	52
7.2.1.2.1	Apartment heat transfer units	53
7.2.1.2.2	The heat distribution network	57
7.2.1.3	Solar-supported heat supply systems – two-pipe networks combined with decentralised domestic hot water storage units	58
7.2.1.4	Advantages and disadvantages of solar-supported two-pipe heat networks	60
7.2.2	Solar-supported heat systems with four-pipe networks	62
7.2.2.1	Solar-supported heat supply systems using four-pipe networks combined with single storage tank systems	62
7.2.2.2	Solar-supported heat systems: four-pipe networks combined with two-tank systems	64
8	Dimensioning	66
8.1	Dimensioning of solar thermal systems	66
8.1.1	Collector area and solar storage unit volume combined with two-pipe networks	66
8.1.1.1	Dimensioning nomogram with defined specific solar storage volume	67
8.1.1.2	Dimensioning nomogram with variable specific solar storage volume	70
8.1.1.3	Determining the influence of the inclination and orientation of the collector area	72
8.2	Dimensioning for security of supply	73
8.2.1	Supply of space heating and domestic hot water	73
8.2.2	Interaction between conventional heat generator and load equalisation storage tank	74
8.2.2.1	Determining the overall volume of the energy storage unit	76
8.2.3	Dimensioning of heat distribution network	77
9	Minimisation of heat losses	78
9.1	Energy storage tanks	78
9.1.1	Heat losses from energy storage tanks	79
9.1.2	Single-storage-unit systems instead of multi-storage-unit systems	80

9.2	Heat losses and pipework design	82
10	Investment costs, grants and economic efficiency	84
11	Plant management and monitoring	87
12	List of references	90
13	Index	92

2

Introduction

The thermal use of solar energy is a long and successful tradition in Austria. Thus in the last 20 years more than 2.5 million square metres of solar collector area have been installed in Austria (including swimming pool absorbers), which represents an average collector area of 0.3 m² per inhabitant as of 2002 (Faninger et al., 2003). Within the EU, only Greece has a slightly higher success rate. Today this collector area already covers more than one percent of Austrian low-temperature energy requirements.

2.1

Market penetration and potential of solar thermal systems in multi-storey residential buildings

Motivated by the already high market penetration in the field of single family homes (the figure is already much higher than ten percent), solar thermal systems are being implemented to an increasing extent in multi-storey residential buildings. At the present moment in time, around 750 multi-storey buildings in Austria are equipped with thermal solar plants. In relation to the roughly two million principle residences in multi-storey residential buildings (this corresponds to around 43% of the Austrian population) it can, therefore, be deduced that around 1% of all flat-owners or tenants are able to enjoy the advantages of a thermal solar plant (Fink, 2003).



Figure 1: Efficient solar-supported heat supply system designs as standard in multi-storey residential buildings (picture source: BRAMAC Dachsysteme International, Upper Austria, Austria).

On the one hand, potential applications remain untapped and, on the other hand, particularly large solar thermal systems in multi-storey residential buildings allow much lower specific system costs than, for example, small-scale plants. Thus solar systems do not only help to achieve economic heating prices, but they also reduce CO₂ emissions in a cost-effective manner. The public sector has, in part, already recognised the potential and is increasingly backing the use of solar energy (as well as other technologies) in new buildings and in existing multi-storey residential buildings to attain climate protection goals. This is demonstrated by the granting of funds for the implementation of solar thermal systems in multi-storey buildings in practically all the federal states of Austria as well as grants from various towns and communities.

2.2

Innovations and the economic factor

Due to its long tradition of solar plants, a large number of the innovations to emerge in recent years originated in Austria. Numerous innovations meant that, on the one hand, large solar thermal systems were implemented in residential buildings in Austria and, on the other hand, Austrian companies have also constructed large plants in residential buildings abroad. This includes the following:

- Development of large-area collectors and the implementation of crane assemblies
- Industrial production of solar collectors
- Aesthetically pleasing and cost-effective integration of solar collectors in buildings
- Heating of solar non-potable water and heating support (combined systems) in multi-storey residential buildings
- Measuring and analysis of solar-supported heating networks in multi-storey residential buildings
- Definition of holistic solar-supported heating networks
- Innovative financing models for large solar thermal systems

In the year 2001 around 240,000 m² of solar collector area was exported and around 160,000 m² in 2002 (this corresponds to 1.5 and 1.0 times the domestic market volume, respectively) (Faninger et al., 2003). This means that in these two years Austria accounted for around one quarter of the overall production of solar collectors in the EU. Apart from the economic success, the Austrian solar industry (domestic market and exports) provides nearly 3,000 jobs.



Figure 2: 1.248 m² solar thermal collector area produced by an Austrian manufacturer on the roof of eight multi-storey residential buildings in Helsinki (picture source: AEE INTEC).

2.3

Motivation for this planning handbook

Extensive know-how about solar-supported heating networks in multi-storey residential buildings is available at selected sites in Austria. Apart from specific developments with regard to system components, numerous further developments have been made in the past few years with regard to holistic system behaviour and integration into buildings. Extensive tests based on measuring techniques provided important empirical values from practical applications. It is the major goal of this planning handbook to focus this specific know-how and also to make it available to all the actors and multipliers.

The aim of this book is to present a holistic approach to the planning, implementation and management of solar-supported heating networks in multi-storey residential buildings. In the short term, the declared goal has to be to define solar-supported heating networks as a standard for new multi-storey residential buildings and to step up activities with regard to existing buildings. After all, every renovation (structural engineering or facility management) that does not employ a solar system represents a lost opportunity, in terms of reducing the operating costs and CO₂ emissions, until the next renovation (generally a period of several decades).



Figure 3: 274 m² solar thermal collector area produced by an Austrian manufacturer on a housing estate with 197 apartments (picture source: Kappei SOLAR FUTURE TECHNIK, Germany).

The high technical standard of modern solar-supported heating networks means there is no reason to delay a decision in favour of a solar thermal system. Moreover, the impending shortage in the global energy supply and the already tense situation with regard to the global climate as a result of burning fossil fuels also encourages this decision.

3

A holistic approach to solar-supported energy supply systems

In various studies, the product and installation quality of solar thermal systems has been analysed in existing plants. Thus, for example, 75 solar energy plants in Vorarlberg were examined and their technical condition evaluated (Schlader, 2002). 25% of the plants were in perfect condition, 50% revealed slight problems and the remaining 25% of the plants displayed considerable technical defects which had an impact on the plant's operational efficiency.

It is probable that these results are not only true of Vorarlberg (Austria) but can be applied to other Austrian federal states in a corresponding manner. It does, however, have to be said that this result is not specific to solar thermal systems but rather describes the prevalent planning and installation quality of conventional heating systems as well. In contrast to conventional heating plants, however, solar thermal systems are subjected to tests and measurements of this kind. Experience shows, moreover, that as a result of testing solar thermal systems it was also frequently possible to detect

defects in conventional heating supply systems which would otherwise not have been discovered. In many cases this led to the first attempts at defining holistic solar-supported heating networks.



Figure 4: Efficient solar-supported heating networks demand a holistic approach to the planning, implementation and management. This includes the solar thermal system (left), the conventional heating systems (middle, in this case biomass) as well as the heat distribution system (right) (picture source: AEE INTEC).

One mistake frequently made in the planning and implementation of solar thermal systems is that the solar thermal system is considered in isolation with regard to integration into the building, plant hydraulics and energy savings. The interaction between the architecture, the solar thermal system, conventional heat generators, heat distribution and the heat supply to the consumers (domestic hot water, space heating) is not taken into sufficient consideration. Likewise the subjective needs and requirements of the user are frequently not adequately considered.

Experience has shown that all of these requirements have to be acted on during the planning phase (integral planning) and given utmost attention during implementation. This requires procedures adapted both to the planning and implementation process, a holistic approach and the early inclusion of all of those concerned with energy in the planning, implementation and plant management process. In this way special requirements can be recognised in good time, interfaces can be clearly defined and areas of competence determined (including warranties). In this respect, Figure 5 provides a procedural diagram as an example of the realisation of holistic and integral solar-supported heating supply systems.

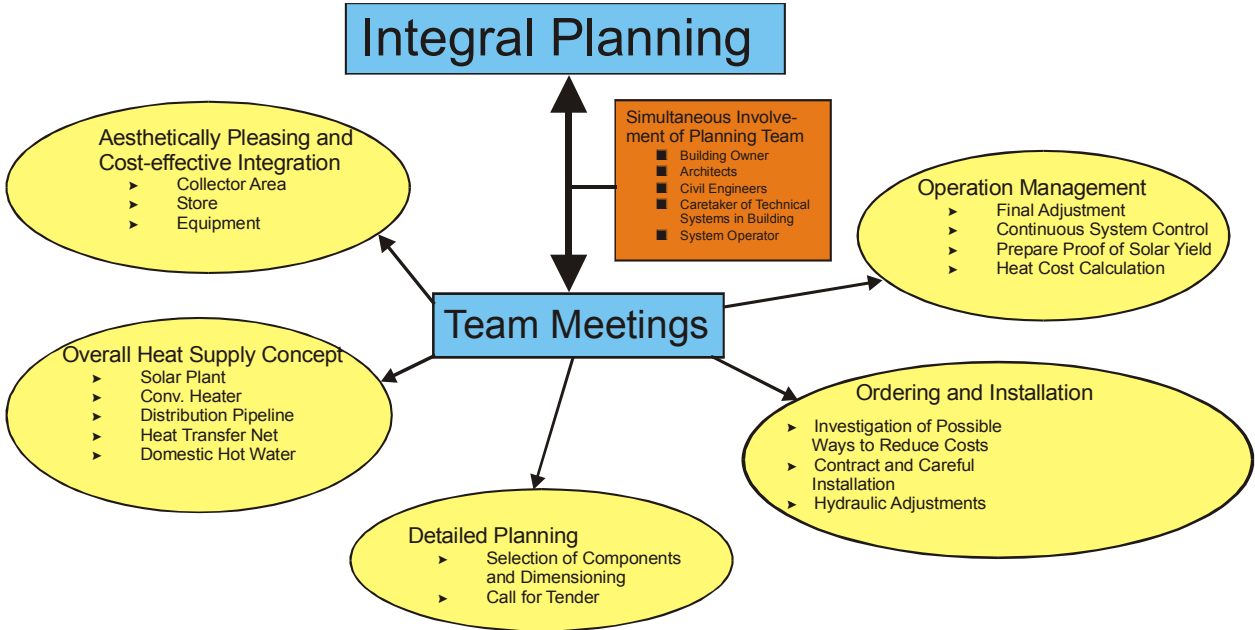

Figure 5: Method for the holistic use of applied solar-supported heating systems.

In the following, aspects will be discussed which, on the one hand, describe the interrelations and, on the other hand, illustrate the absolute necessity for a holistic approach to solar-supported heating supply systems.

3.1

Low average collector temperatures as an energy-related success factor

The average collector temperature $((T_{\text{inlet}}+T_{\text{outlet}})/2)$ is the decisive value for the present high-quality collectors to attain high solar yields throughout the year. The lower the average collector temperature, the higher the efficiency rate of the collector and thus the solar yield. Without a doubt, it is wrong to believe that the demand for the lowest possible average collector temperature can only be adequately achieved by the solar thermal system alone.

It is rather the case that apart from the dimensioning of the collector area, other aspects and parameters determine the temperature level at the collector:

- Type and manner of integration of the conventional heat generator
- Principle and dimensioning of domestic water heating
- Principle and dimensioning of space heating supply
- Dimensioning of the storage unit volume available for the solar thermal plant
- Mixing rate of energy storage unit (water amounts, geometries of storage units, etc.)

The influence of the interaction of the overall heating supply system on the average collector temperature, and thus on the efficiency of the collector, can be seen by way of example in Figure 6. Heating supply concepts adapted to the requirements of solar energy plants achieve much lower average collector temperatures and thus higher collector efficiencies in all operating points.

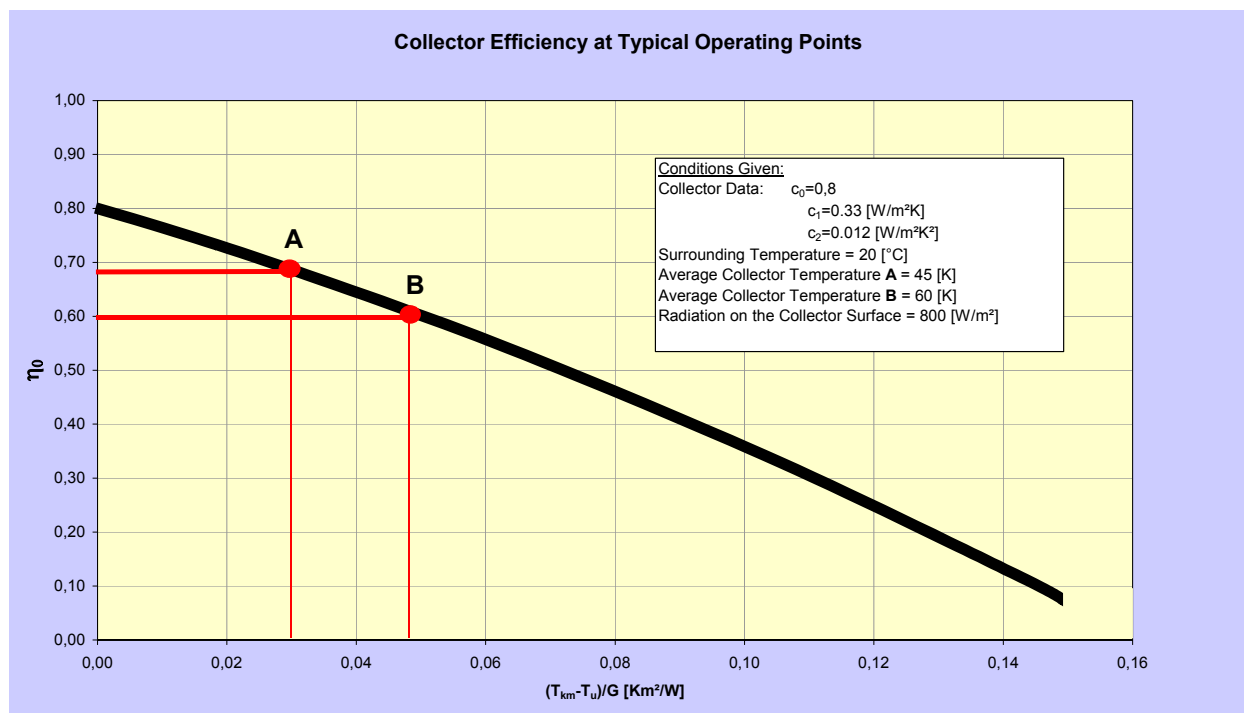

Figure 6: The influence of the temperature on the achievable collector efficiency. An Adapted holistic heating systems with lower mean temperature (operating point A) achieve essentially higher collector efficiency than for the example a solar thermal system with high return temperatures in the heat distribution system (operating point B).

Only the integration of heat generators adapted to the needs of solar thermal systems or their heat emission components permits low average collector temperatures and thus the highest possible solar yields.

3.2

Enhancement of the solar coverage and reduction in auxiliary heating requirements as a result of very low heat losses in the system

It is not only the solar yield which is of decisive significance in holistic considerations but also the overall annual system utilisation rate. Highly efficient solar thermal systems lose their relevance in the case of a thermally inefficient (lossy) residual system, which is reflected in very low solar coverage rates. Figure 7 shows the example of the system losses of a solar-supported heating supply system from the heat generators (energy input – without any losses during energy conversion) to the consumers (useful energies for domestic hot water and space heating). On the basis of numerous measurements, it becomes clear that considerable heat losses occur in the system sections of heat storage and heat distribution, which in the case of exceptionally inefficient heating supply systems can also lead to system efficiencies below 50%.

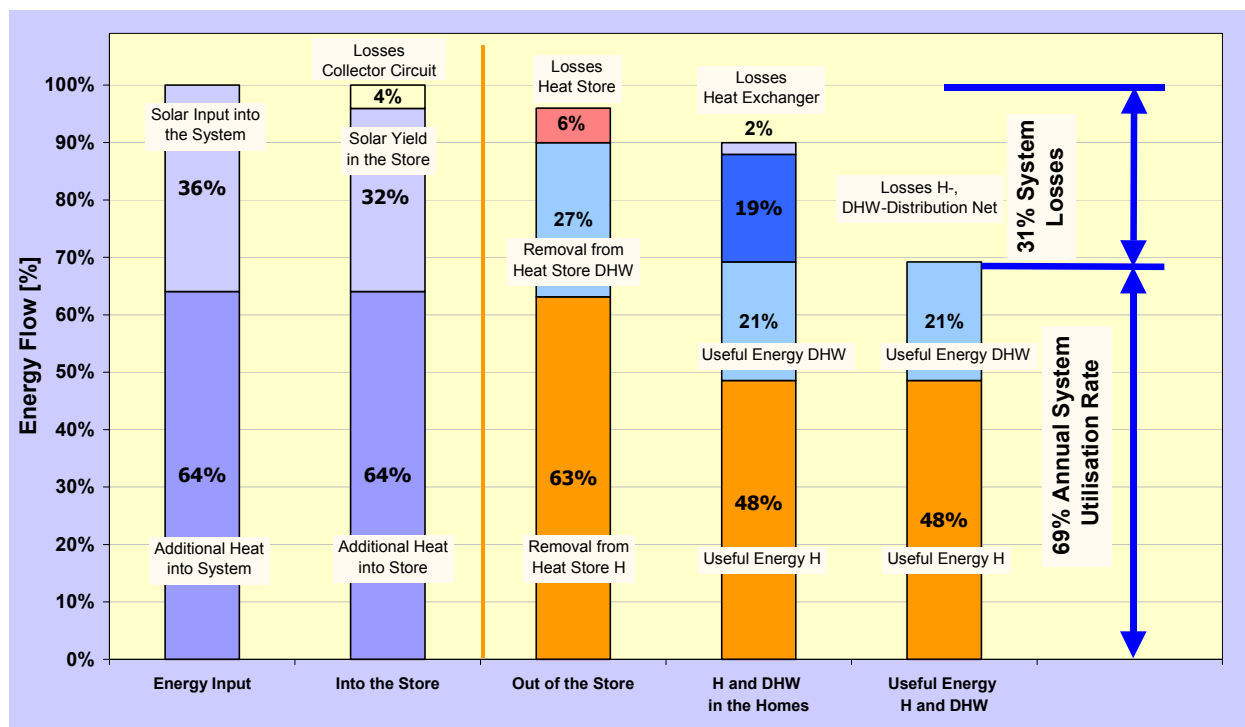

Figure 7: Exemplary description of the system losses of a solar-supported heating supply system (from the heat distributor to the end user with an annual degree of system utilisation of 69%).

On the one hand, this problem has to be tackled by appropriate system hydraulics and, on the other hand, by an improved design of the thermal insulation standard.

- Selection of simple system hydraulics with conceptionally reduced system temperatures avoiding pipework
- Positioning of the energy storage unit at the shortest possible distances from the site of heat generation (solar collectors, conventional source of heat/energy) and to the consumers (domestic hot water and space heating)
- Avoidance of outside pipework
- Selection of one-storage-tank system without storage unit batteries
- Improved standards with regard to storage unit insulation

- Insulation of all indoor pipework in accordance with the requirements of ÖNORM M7580
- Improved insulation standards for outdoor pipework
- Use of insulation for valves and fittings

3.3

Greatest possible comfort for users

Buildings are basically constructed for the people who live in them or their users. For this reason, subjective comfort and living habits should not be prescribed by engineers but rather defined by the users themselves.



Figure 8: The comfort is increased by the utilisation of the solar thermal system and not the other way around (picture source: Ultimate Lifestyle).

This aspect should be given major attention in the planning and implementation phase of facility management plants and should cover the following points:

- An important comfort parameter is having domestic hot water on tap as and when required
- Standardized calculation principles are important. In this respect, the subjective feeling of comfort experienced by individuals should not be forgotten. This means that room temperatures below or above standardised levels should be possible, as required by the occupants.
- The occupants' different lifestyles also involve different rest and active phases. This means that the usual reduction of heating levels during the night should be reconsidered in the light of this aspect.
- In modern heating supply plants the selection of heating limit temperatures can be determined by the users themselves.

Building equipment and appliances which make use of renewable sources of energy or which enhance energy efficiency are frequently associated with restrictions in terms of comfort. The fact that this is not actually true and that an increase in comfort is in fact achieved by the use of renewable sources of energy as a result of the system (as well as psychologically) has to be conveyed to the end consumer more explicitly in the future. In this respect, it should be mentioned that with intelligent system solutions an increase in comfort is not automatically the same as a higher consumption of energy.

Systems with the greatest possible water hygiene

Water is life. Unfortunately microorganisms are also aware of this fact. Whilst cold water pipes are almost completely free of microorganism contamination representing a health risk, the conditions in hot water pipes are ideal for such contamination. Deposits of limescale, corrosion products, rubber washers, remains of hemp and fittings create ideal conditions. As a consequence, it is necessary to design potable water heating systems in such a way that bacteria which represent a health risk (triggering legionnaires' disease or Pontiac fever) will die quickly. Since bacteria are strongly dependent on temperature for growth requirements and life span, potable water heating systems have to be designed so that there is absolutely no risk of infection for users.

As with conventional plants for non-potable water heating, the design of solar-supported systems has to be adapted to these needs. In cases where there is absolutely no risk it is possible to select a system configuration which will not impair the solar yields and system efficiency. System solutions of this kind (continuous flow water heaters or storage tanks) are available on the market for all different kinds of applications for solar thermal plants.



Figure 9: Hygienic supply of domestic hot water and the highest comfort are a central issues by solar-supported heating networks (picture source: Photo Alto).

Exploiting opportunities for reducing capital costs

A holistic approach to solar-supported heating supply systems is, however, not the only aspect which offers enormous potential for reducing capital costs; structural engineering integration is also of great significance. In both fields the guiding principle is to make use of any potential synergies. However, to be able to recognise these synergies and then implement them, holistic planning which recognises interfaces and cooperation amongst the different companies and experts involved in the building project is a necessity.

- Integral planning might lead to higher planning costs but, as a whole, it reduces the capital costs quite considerably.
- The integration of solar collectors into a building (roof or facade integration, use of collectors as shading elements) represents an additional benefit. Apart from the fact that a separate roof structure is not needed, conventional weather protection (roof covering or façade construction) is not required for the area covered by collectors.
- The space requirements and the specific costs of the domestic installations can be reduced by using them for more than one purpose (heat storage unit, pressure maintenance plants etc.).
- The space requirements of domestic installations (storage unit, conventional source of heat, pipework, other system components, etc.) have to be taken into consideration in good time.

- An attempt should be made to use energy shafts and any necessary (empty) pipework more than once.
- Outdoor or underground pipework is particularly cost-intensive because it is of a special design and considerable cost reductions can be achieved if such structures are not used.
- Simple heating supply concepts, adapted to the actual needs of the users, are as a rule less cost-intensive than various types of hydraulic pipework.
- Only use standard fittings which are really needed for well-tuned hydraulics.
- One single control device for the entire heating supply leads to interface reductions and reduces the capital costs.
- The combined design of the functions which follow "regulation" and "operational and yield control" results in lower capital costs.
- Examination of all the funding possibilities from public sources (direct grants, low-cost loans or annuity allowances) before commencing building work.

3.6

Low operating costs for users with the greatest possible reliability of supply

It is difficult to operate solar thermal plants in the form of monovalent heating supply systems which is the reason why it is impossible to dispense with a conventional heat generator. From an economic point of view, therefore, solar thermal systems are viable as a result of reducing the operating costs and not the capital costs. In the residential building sector in particular, where the end consumer often prefers low capital costs to low long-term operating costs, a great deal of work has to be done by consultants and builders to provide more information. This consideration is becoming more important provided that the increasing cost of fossil forms of energy is also taken into account. Figure 10 shows the development forecast by energy experts (Campbell et al., 1998) for the total world oil production. In accordance with this, the upper limits have already been exceeded in some regions rich in oil. As far as world production is concerned, this "Big Rollover" is expected in the middle of the current decade. In the light of this development, those responsible for the construction of residential buildings will have to take measures right now so that the anticipated rise in energy prices will not lead to an explosion in the occupants' operating costs and also to ensure the security of the future energy supply.

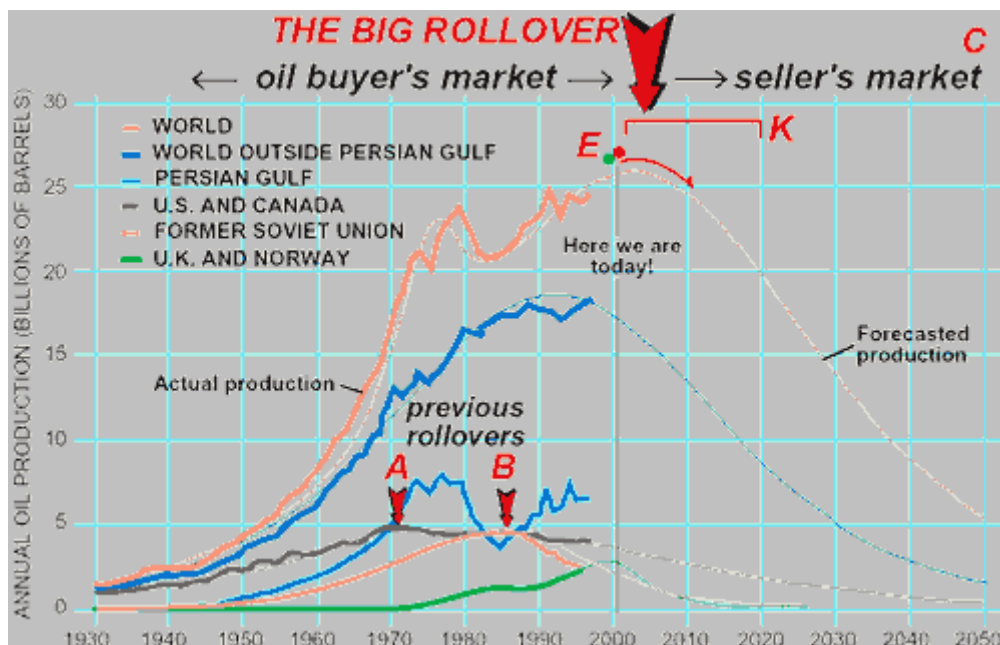

Figure 10: The development of the world oil production. Documented until 1998, prognosticated until 2050 (picture source: Campell et al., 1998).

The following include some approaches for reducing operating costs and securing the supply:

- Reduction of heating requirements as a result of implementing a corresponding thermal insulation standard in new buildings or when renovating using ventilation heat recovery
- Reduction of domestic hot water requirements by using water-saving fittings
- Heating supply systems with low heat losses and the highest possible annual total efficiency factor
- Solar-supported heating supply systems with the highest possible solar coverage
- Coverage of remaining heating requirements by renewable forms of energy (e. g. heating with pellets and chips)
- Regular monitoring (in large-scale plants automated plant monitoring) of whether the heating supply system is functioning and adherence to the necessary maintenance intervals
- Use of energy-saving household appliances
- Use of rain water
- Information for occupants regarding the influence of user behaviour

4

Solar radiation

The sun is the central supplier of energy in our solar system. It is a ball of gaseous substance in the centre of which nuclear reactions are constantly taking place. The surface of the earth receives around half its exoatmospheric radiation energy from the sun in the course of a year because when it penetrates the earth's atmosphere some of the radiation is absorbed or reflected into space. However, the radiation energy which reaches the continents still amounts to 219,000,000 billion kWh per annum. This represents 2,500 times the current global energy requirements.

4.1

Usable radiation capacity and annual usable radiation energy

On a clear and cloudless sunny day the radiation capacity may reach up to 1,000 W/m². Measurements have revealed that if the sky is slightly overcast but the sun can still be seen it is possible to achieve a top power of 1,200 W/m² in the form of reflections from the clouds.

What is known as global radiation consists of direct and diffuse radiation. Direct solar radiation is the fraction that arrives from the direction of the sun relatively unimpeded, whilst diffuse radiation reaches the surface of the earth from all directions uniformly. Diffuse radiation is the result of scattering processes in the atmosphere. This fraction depends greatly on the time of year, the level of cloud cover and on climatic and geographical conditions as well as on altitude. Depending on these parameters, the fraction of diffuse radiation fluctuates in Central Europe between 40% in May and up to 80% in December.

The sunshine duration and the radiation intensity depend on the time of the year, weather conditions and naturally on the geographical location. Thus the annual total global radiation in the sunniest regions of the earth can amount to more than 2,200 kWh/m².

In Austria, annual solar radiation is between 1,000 and 1,400 kWh/m². On the one hand, these differences can be explained by the large range of altitudes (high altitudes mean hardly any days of fog) and on the regional differences in the weather which are considerable.

Figure 11 shows the mean long-term total annual global radiation on a horizontal surface for different regions in Austria. From this it can be seen that although there are privileged areas the use of solar

energy would make absolute sense in every region of Austria. This statement can be illustrated by one simple example. Basically the southern side of the Alps would appear to be more favoured in terms of sunshine, but it should be remembered that the province of Upper Austria, which is located on the northern side of the Alps, has the highest density of solar installations (0.3 m² flat collector per inhabitant) in Austria (status: end of 2002).

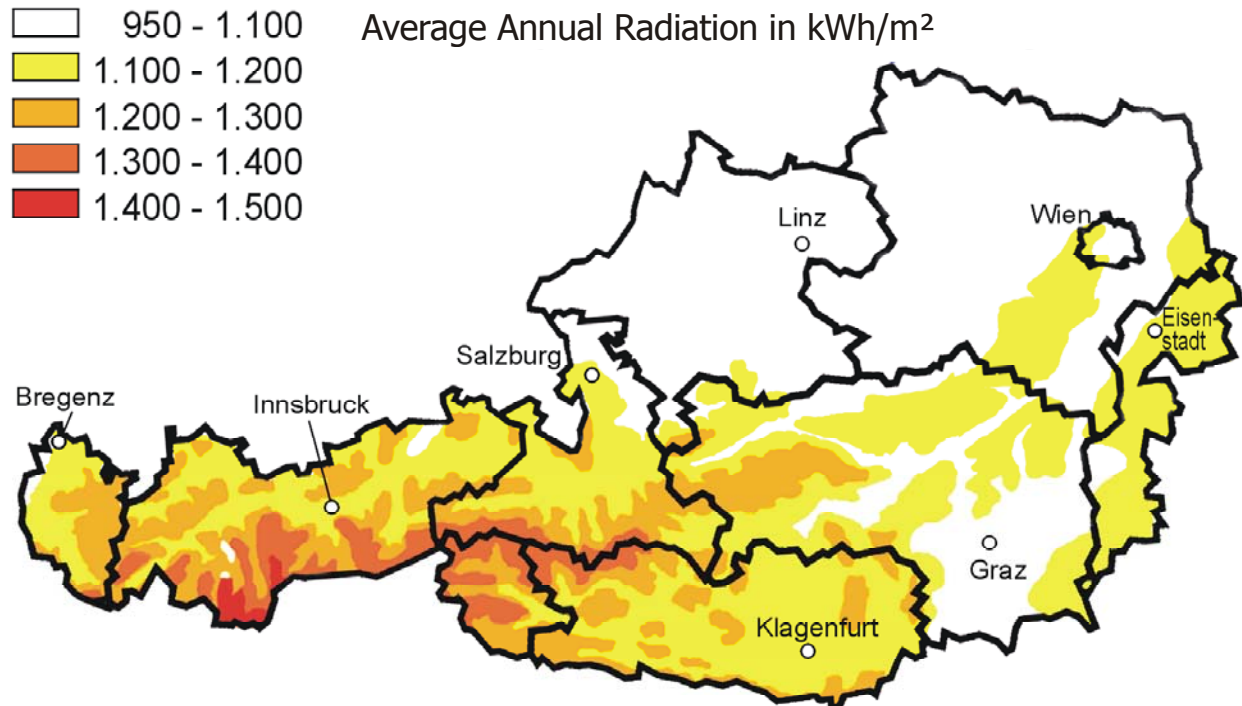

Figure 11: Annual mean long-term total global radiation on a horizontal surface for different regions in Austria in kWh/m².

The availability of suitable sets of weather data for the design of the solar thermal systems is very good in Austria. The simulation programs most frequently used for the design of solar thermal systems (TSOL, 2003; POLYSUN, 2003) have extensive databases with sets of weather data for the largest towns and cities in Austria.

4.2

Distribution of solar radiation throughout one calendar year

The average duration of sunshine in Austria is approximately 2,000 hours of which around three quarters is recorded in the summer (see Figure 12). In contrast, in the months with the highest energy demand (November to February) only one sixth of the overall annual energy is irradiated.

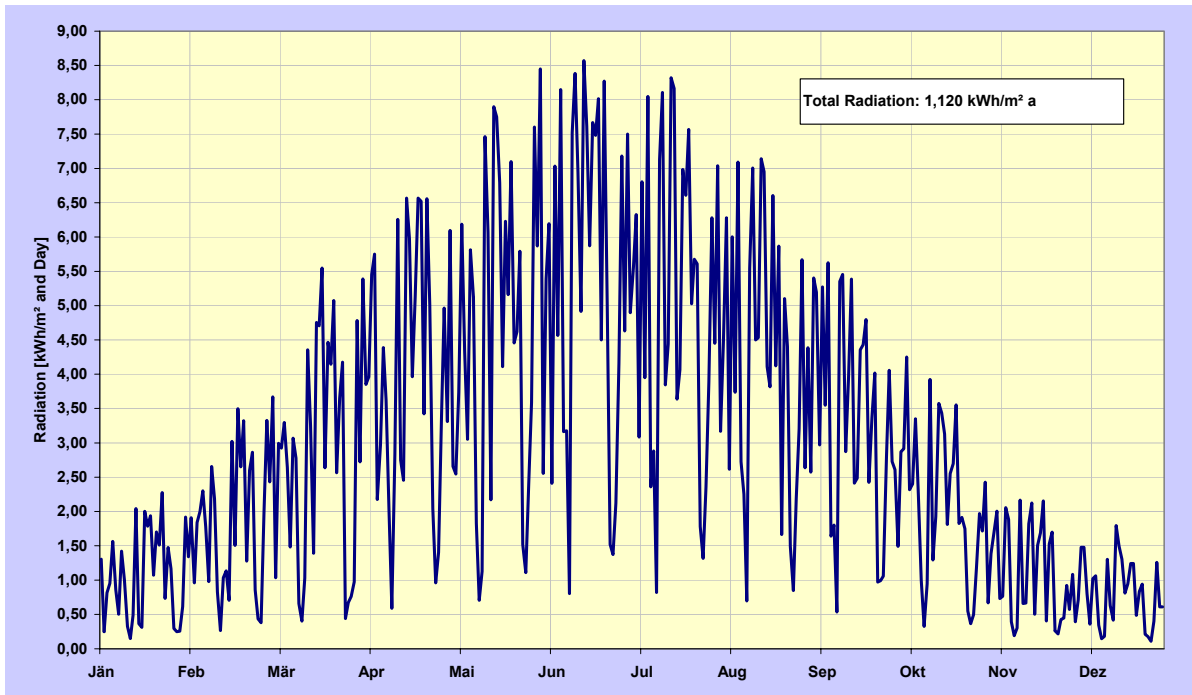

Figure 12: Solar radiation on a horizontal area in Graz, Austria, created from mean month temperatures generated from values over many years.

The annual course of solar radiation in accordance with the seasons shows clear advantages for the use of solar energy for applications where major consumption is in the summer months or for other applications which have constant consumption throughout the year. However, in the transitional period (March to May and September to October), the Austrian climate permits high irradiation rates, which provides favourable conditions for solar support of space heating applications.

Figure 13 shows the course of average annual global irradiation in three areas at a different incline (90° , 45° , 0°) for locations in Graz. The highest annual irradiation of $1,260 \text{ kWh/m}^2$ is on an area with an incline of 45° , followed by the horizontal area with $1,120 \text{ kWh/m}^2$. The area inclined at 90° is slightly less favourable with annual irradiation amounting to 900 kWh/m^2 .

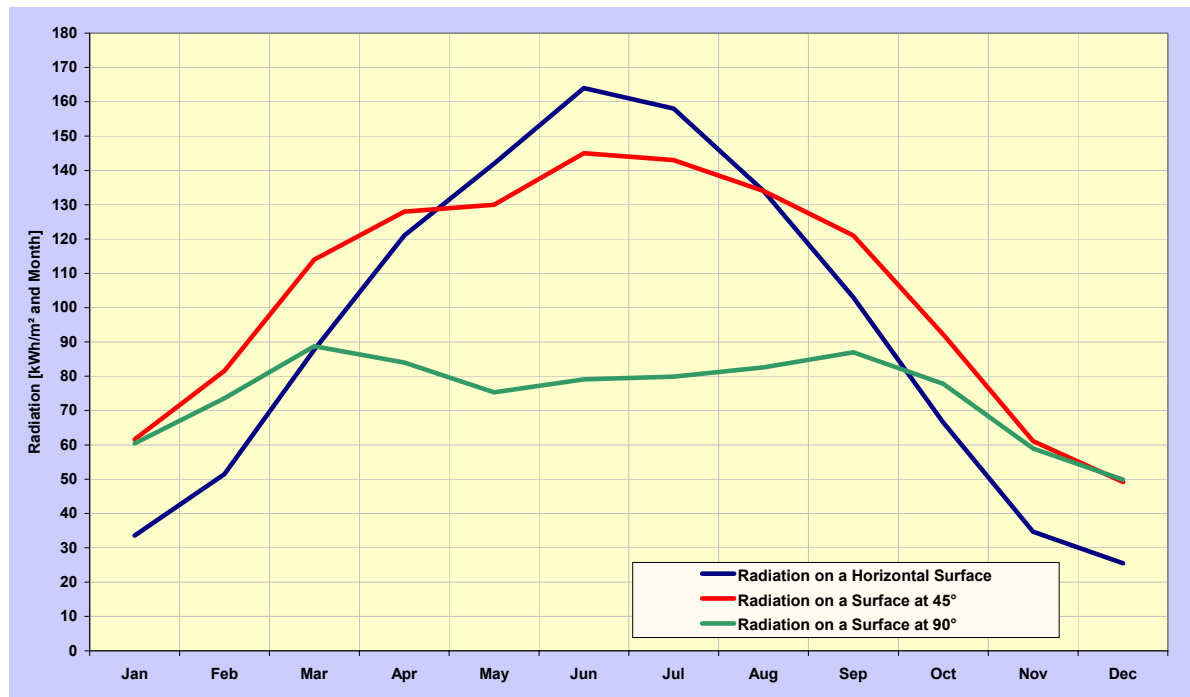

Figure 13: Average annual global irradiation in three areas at a different incline, Graz, Austria.

The seasonal course of irradiation is of interest, in addition to the annual absolute global irradiation figures. With respect to the three inclines compared, the highest radiation on a horizontally inclined area was achieved in May, June and July and the lowest radiation in the months of January, February, October, November and December. In this respect, the vertical area displays almost constant radiation course throughout the year. The area with an incline of 45°, however, has advantages for all-year applications compared to the other two inclines. In practice this means adjusting the incline of collector elements to suit the consumption profile.

5

Heating requirements in multi-storey residential buildings

To avoid the undesirable over-sizing or under-sizing of solar thermal plants, it is important to have as precise a knowledge as possible of the energy requirements when designing the solar-supported heating networks. The heating requirements both in multi-storey residential buildings and in the single family home sector result from the consumption groups of domestic hot water and space heating. Although the need for domestic hot water is almost constant throughout the year, the heating energy demand is subject to enormous seasonal fluctuations (see Figure 14). The domestic hot water demand is basically independent of climatic influences and has only a narrow fluctuation range in multi-storey residential buildings. The amount of heating energy, required on the other hand, depends enormously on climatic influences and the thermal insulation standard of the building to be heated, which is reflected by considerable seasonal fluctuations. Accordingly, the demand for domestic hot water as a fraction of the overall energy requirements in multi-storey residential buildings ranges as a rule between 10% (old buildings) and 50% (low-energy houses). The constant improvement in building codes and the incentive provided by corresponding funding models to considerably reduce heating energy requirements in new and renovated building mean that the demand for domestic hot water is, however, becoming more significant.

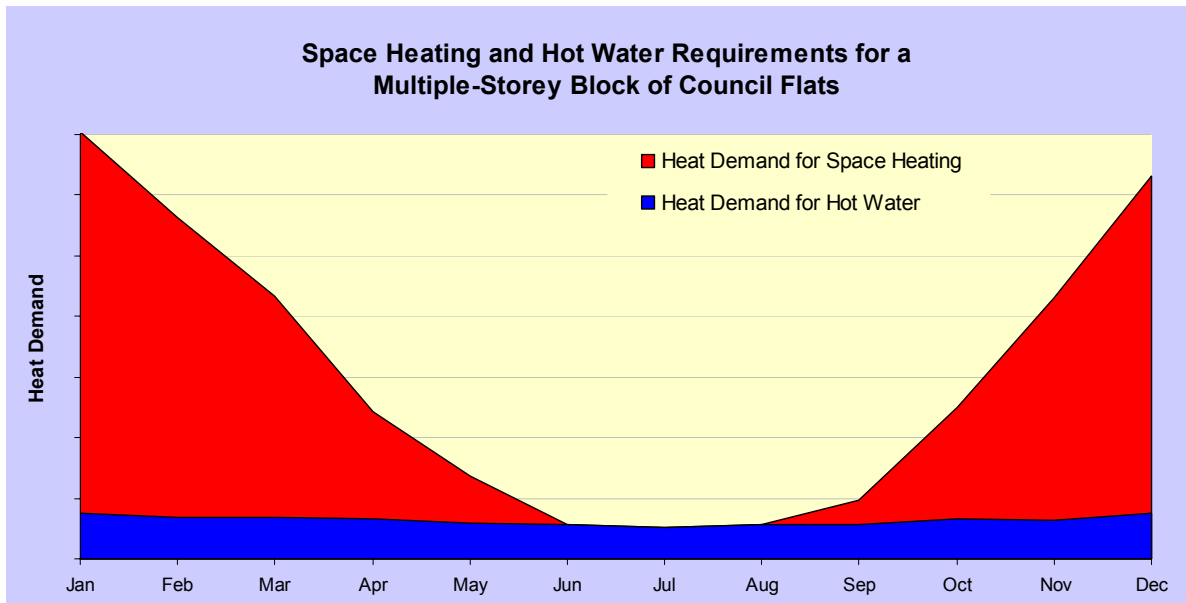

Figure 14: Space heating and domestic hot water requirements for a multiple-storey block of council flats (25 flats, heating load: 100 kW, 80 m² collector area, solar coverage: 18%).

Apart from the actual heating requirements (domestic hot water and space heating), there are sizable heat losses even with optimised heating supply concepts and a careful design. These heat losses (pipework losses, storage unit losses) must be compensated by the heat generators and they thus also affect the solar thermal system, which explains why heat losses should also be taken into consideration in the dimensioning phase. In practice, it has been shown that it is sufficient to merely estimate the heating losses.

If adequate knowledge is available on daily heating requirements for domestic hot water and space heating with respect to the dimensioning of the solar thermal plant, then in order to guarantee the energy supply consideration must be given to peak loads in designing the heat distribution network, the conventional heat generator and any possible stored energy volumes. In order to design a system that can meet these loads, detailed information on the distribution over time of the heat load must be obtained. The heat losses play a negligible role in this content. Reference values are available in Section 8.2.

The following Sections describe approaches for determining the heating requirements with a sufficiently high time resolution as needed for the dimensioning of solar thermal plants.

5.1

Determining heating requirements for domestic hot water

5.1.1

Determining daily consumption

The need for domestic hot water for multi-storey residential buildings depends basically, but not exclusively, on the number of occupants. Apart from the number of people, the standard of living, age, occupation, time of the year etc all play an important role, as does the way in which domestic hot water consumption is calculated (is a water meter/heat quantity meter installed or is the hot water calculated in terms of floor space). If the domestic hot water is calculated in terms of floor space, then

empirical values reveal a higher consumption than comparable hot water calculations using a hot water or heat quantity meter. Reference values for consumption from the literature (Recknagel, et al., 2003) reveal considerable differences in daily consumption (table 1).

The daily personal domestic hot water consumption is usually given in litres at a certain temperature level (e. g.: 30 l at 60°C or 43 l at 45°C). To calculate the energy required for heating the water, it is necessary to know the average cold water temperature at the site in question. As a rule, in large parts of Austria this can be taken to be approximately 12°C. The necessary heating requirements can be calculated using the following equation.

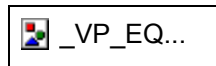

[kWh] *equation 1*

Q_{BW} Energy of hot water in kWh

V Hot water consumption in litres

c_p Specific heat capacity of water (4.2 kJ/litre K)

ΔT Temperature difference between domestic hot water and cold water in kelvin

T_{BW} Temperature of domestic hot water in °C

T_{KW} Temperature of average cold water in °C

Since the general literature available is not really suitable for the dimensioning of the more specific solar thermal systems, numerous measurements of domestic hot water requirements in multi-storey residential buildings have been carried out in the past and characteristic values identified. Figure 15 shows the consumption of 12 multi-storey residential buildings (six each in Austria and Germany). The residential buildings examined range from students' hostels to terrace house units and council flats, which is clearly reflected in the consumption of domestic hot water.

Low-level demands	10 - 20 l
Medium-level demands	20 - 40 l
High-level demands	40 - 80 l

Table 1: Demand for domestic hot water per day and person (multi-storey residential buildings) at a temperature of 60°C (Recknagel et al., 2003)

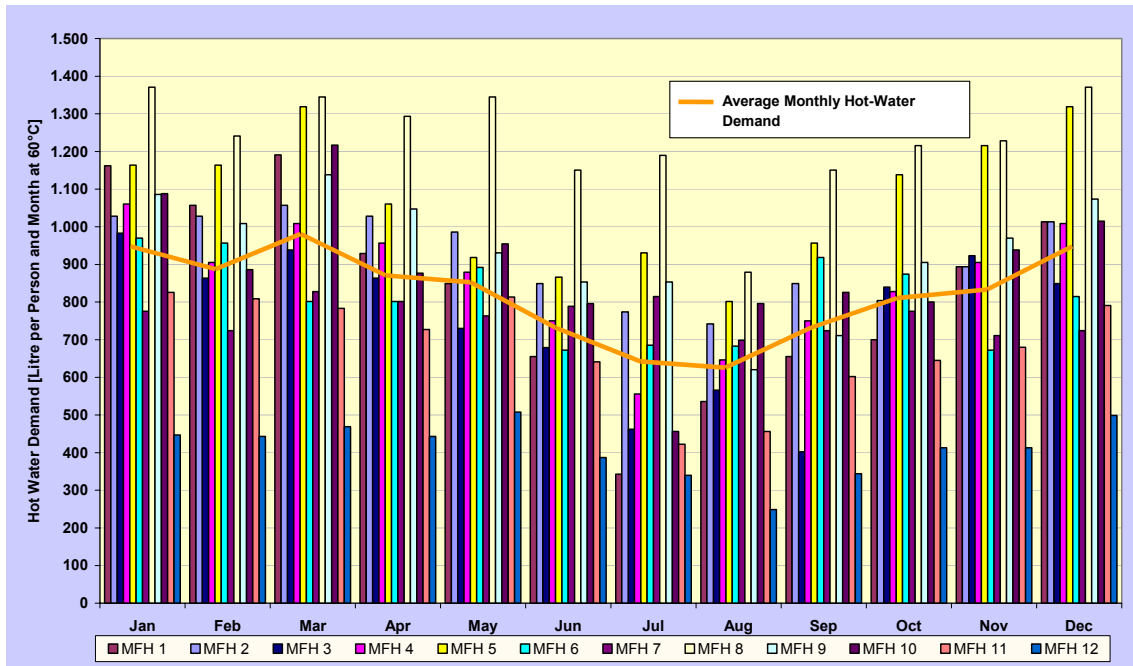

Figure 15: Measured monthly domestic hot water consumption from 12 multi-storey residential buildings during one year. The mean daily domestic hot water demand is just under 30 litres per person and day at 60 °C (Fink et al., 2002; Luboschnik et al., 1997, Gassel, 1997).

On average, just under 30 litres of water per person at 60°C was found to be the average requirement for domestic hot water. However, the differences in monthly consumption clearly show that due to the numerous influential factors it is imperative to re-examine consumption in each building project with regard to the special framework conditions.

With regard to an isolated consideration of the category of council flats (with the exception of various hostels and terrace house units) with standard bathroom equipment, a value of 30 litres per person and day at 60°C can be used to estimate the necessary solar thermal plant size.

5.1.1.1

Calculation of daily consumption for multi-storey residential buildings

With regard to new buildings, when determining the overall daily consumption of domestic hot water the question arises of how many people will actually live in the flats. The number of people can be roughly estimated in two different ways which both make use of statistical evaluations.

Calculation in terms of average floor space:

If the overall usable floor space of the building to be supplied is known, the specific living area per person can be ascertained on the basis of statistics. These statistical evaluations show that in Austria the average floor space per person is around 33 m² (Statistical Yearbook, 1999).

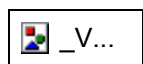

[People] equation 2

X_{Pers} Overall number of persons

W_{NF} Overall usable floor space in m^2

$33 = W_{NFspez}$ (average usable floor space per person in m^2)

Calculation in terms of the average number of people in one flat:

If the number of flats in the building is known, the number of persons per flat can be ascertained on the basis of the average number of persons per flat determined from statistics. Statistical evaluations have shown that in Austria the average number of people per flat is around 2.5 (Statistical Yearbook, 1999).

 **[People]** *Equation 3*

X_{Pers} Overall number of persons

n_w Overall number of flats

$2,5 = X_{Wspez}$ (average number of persons per flat)

Depending on the geometry of the building to be supplied with hot water (frequency of different sizes of flats) a method of calculation can now be selected.

If the overall number of people in the building is known, the following equation can be used to calculate the overall daily energy requirements for heating the domestic hot water.

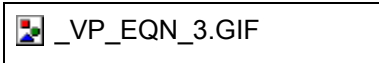
 **[kWh]** *Equation 4*

Q_{BW} Daily amount of energy for the overall supply of multi-storey residential buildings with domestic hot water in kWh

$V_{Pers/Tag}$ Daily consumption of hot water per person in litres (around 30 l at 60°C in council flats)

X_{Pers} Total number of people

c_p Specific heat capacity of water (4.2 kJ/litre K)

ΔT Temperature difference between domestic hot water and cold water in kelvin

T_{BW} Temperature of domestic hot water in °C

T_{KW} Temperature of average cold water in °C

5.1.1.2

Measurement of consumption in existing buildings

The most precise and reliable method of calculating the consumption of hot water is to measure the consumption over a fairly long, representative period. In existing multi-storey residential buildings

water counters or even heat meters may be installed from which the information can be simply and cost-efficiently obtained over a representative period.

If this is not the case the daily domestic hot water demand can either be determined from the person-specific consumption of 30 l per day indicated in Section 5.1.1.1 (suitable for approximate calculations) or recorded by installing corresponding measuring equipment in connection with records of consumption over a longer period. In general, a mass flow counter and heat meter can be envisaged for recording consumption, taking into consideration the way in which the domestic hot water is heated.

- **Flow meter**

This is recommendable whenever the temperature level of the domestic hot water and cold water is almost constant. Determining the temperature level of the domestic hot water and cold water on one single occasion is sufficient as a basis for calculating the heating requirements using the data recorded by the flow meter. The investment costs are lower than with heat meters; however, as a rule it is not as easy to make recordings.

- **Heat meter**

These can be used both with constant and fluctuating temperature levels with regard to domestic hot water and cold water. The investment costs are higher than with flow meters but the recordings (stored monthly values, record of maximum mass flow, etc.) are more convenient.

Provided that in the medium to long term no major conversions or changes in use are to be expected, as a rule, very reliable design data can be obtained and also made available inexpensively. A prerequisite for this is that the flats have a central supply of domestic hot water. With regard to the recording intervals, daily values would be sufficient for the dimensioning of the solar thermal system. A representative period for the recording should be at least a few weeks. If the measurements are performed in summer, the reduced consumption in summer, up to 20% on average, must be taken into consideration (see Figure 15 and Figure 19).

For recording hot water consumption, the position of the flow meter is important (as it is with the heat meter). In this respect, care must be taken that only the hot water consumption is recorded which really flows through the domestic hot water heater. The volume from the tap is of no importance since cold water can be added to a greater or lesser extent depending on the desired temperature. Likewise central devices for the addition of cold water (domestic hot water mixer) are to be taken into consideration. Figure 16 shows the correct functional assembly of measuring devices to record domestic hot water requirements.

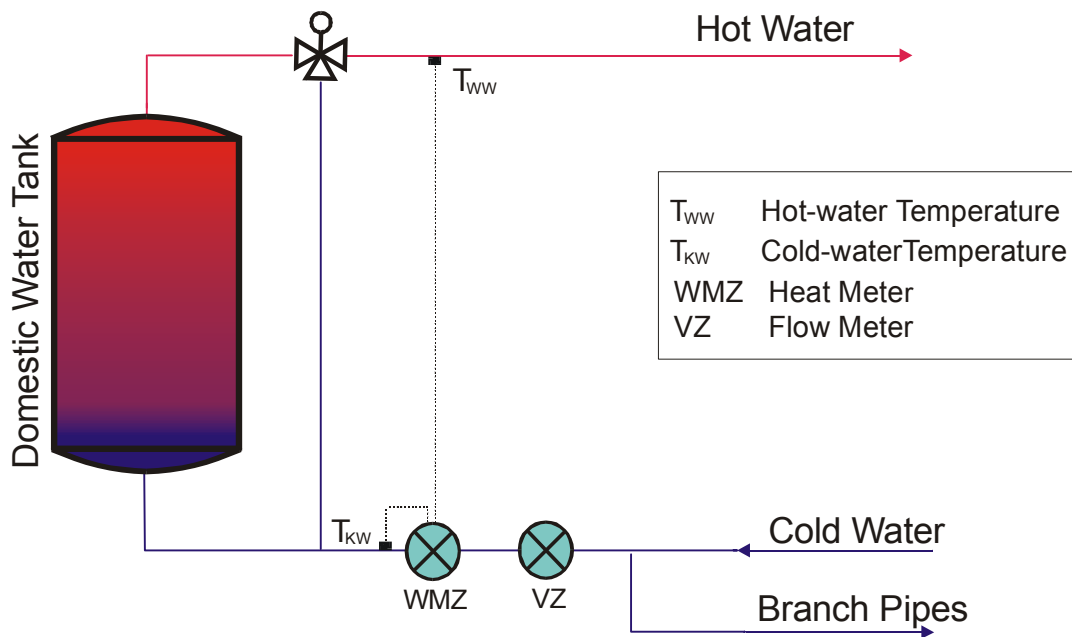

Figure 16: Correct functional assembly of volume flow and temperature measuring devices (volume part and temperature sensors).

In addition to the consumption of domestic hot water, the loss through the hot water distribution pipe, which has to be kept at the desired temperature, and the circulation pipe has to be taken into consideration in non-potable water heating systems. Numerous measurements have revealed that in unfavourable cases these even exceed the actual energy requirements for domestic hot water. For this reason, we recommend that the heat loss in the circulation pipe should also be measured.

5.1.2

Consumption profile

Apart from the average domestic hot water requirements, the consumption profile is another important parameter for dimensioning the system. The consumption profile describes the course of consumption over a defined period of time. For example, annual, weekly and daily profiles are frequently recorded. Knowledge of the consumption profile is particularly important in the case of strongly fluctuating consumption such as in tourist centres or sports facilities. The seasonal consumption profile is of particular interest for the dimensioning of the solar thermal system for multi-storey residential buildings whereas the daily consumption profile does not have a great influence on the system configuration. It is more the case that the highly time-resolved consumption distributions (daily or hourly consumption profiles) are important parameters in the design of conventional heating systems. In concrete terms, security of supply concerns the interaction between the components of storage volume heated by the auxiliary heater, performance of the conventional auxiliary heater and heat exchanger performance.

Figure 18 shows a consumption profile for a weekday recorded with a great deal of effort in multi-storey residential buildings (for example with a daily consumption of 2,000 l at 45°C), as for example used in simulation programmes for the design of solar thermal systems. This daily consumption profile was prepared from extensive measurements, surveys and probability calculations (Jordan et al., 2001). These results were divided into four categories (withdrawal of small amounts of water, medium amounts of water, shower and bath), to which a withdrawal time and a medium volume flow were assigned (see Figure 17). It can be seen very clearly that the category of "small amounts of water" (< 5 l/min) accounts for the greatest annual length of time and the category "bath" (12 to 16 l/min) accounts for the smallest annual length of time.

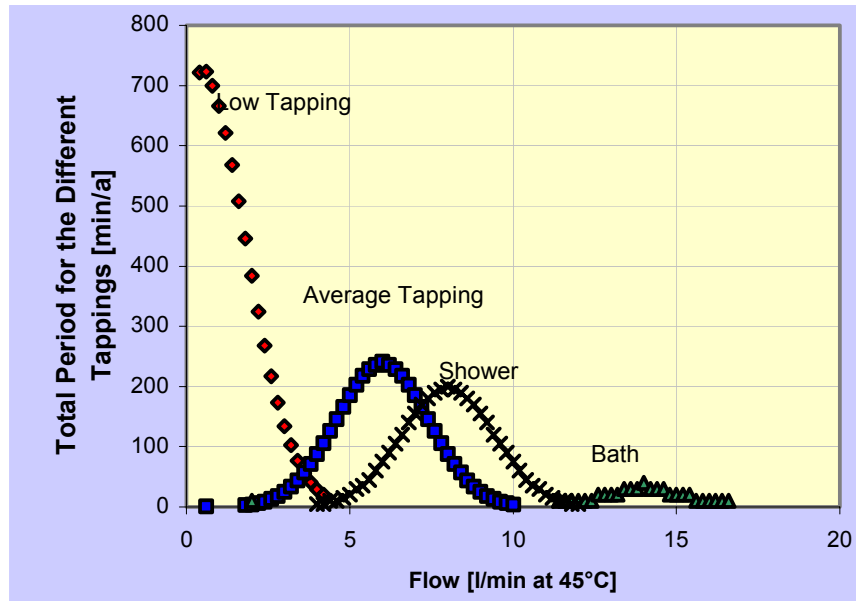

Figure 17: Progression of withdrawal time during different tapping categories as a function of the tapping flow (Weiß, 2003).

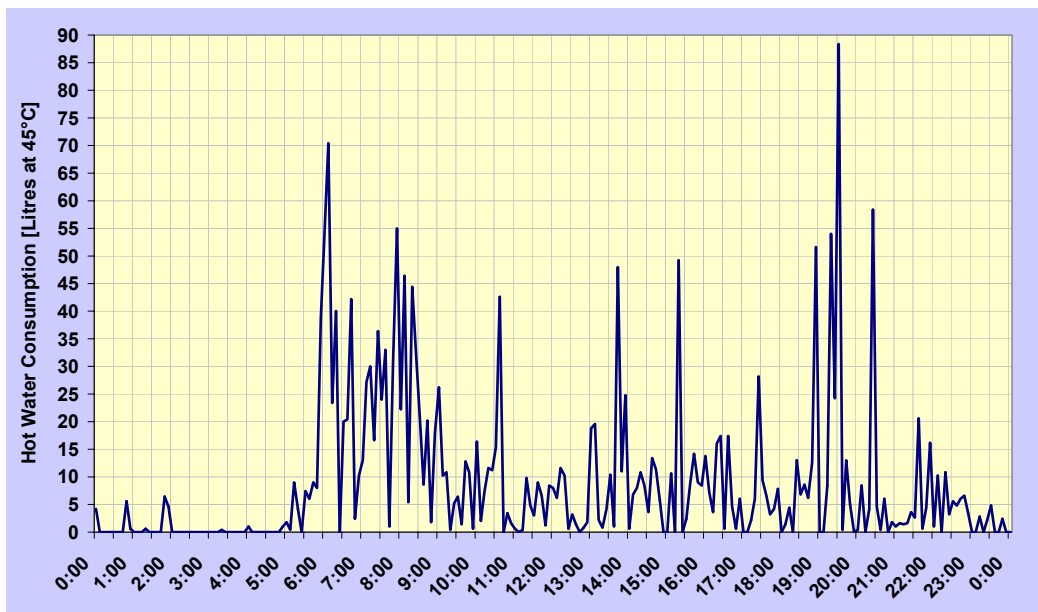

Figure 18: Daily consumption profile for multi-storey residential buildings, constructed through measurements and probability calculations for an example with a daily domestic hot water consumption of 2000 litres at 45 °C (Weiß, 2003).

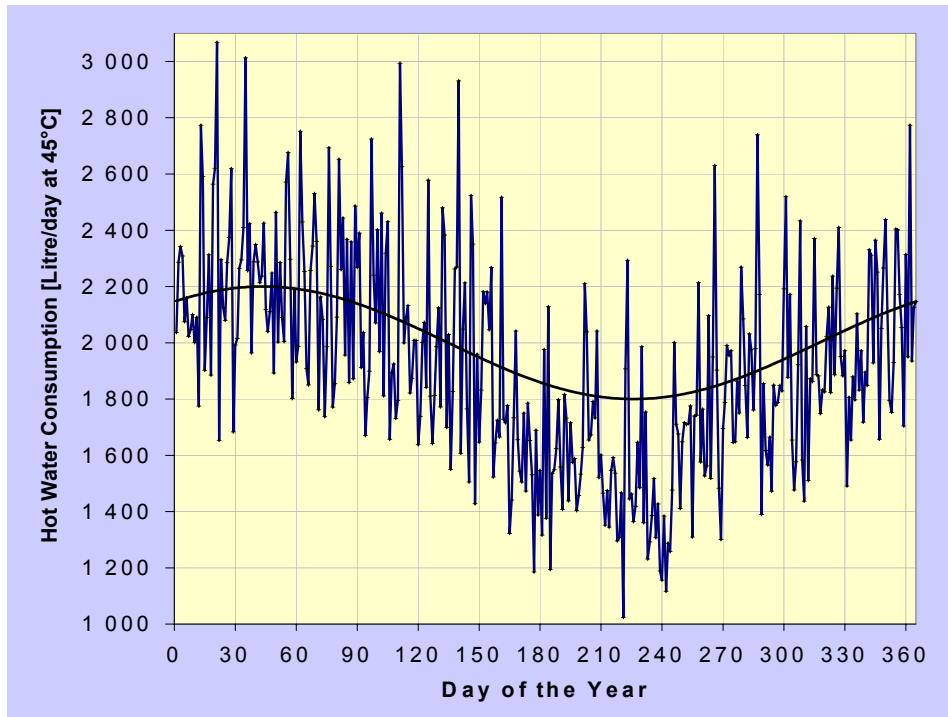

Figure 19: Annual consumption profile generated from the daily consumptions profile where measurements and probability calculations (with a daily mean domestic hot water consumption of 2000 litres at 45 °C) are taken into account (Weiß, 2003).

The annual consumption profile depicted in Figure 19 consists of daily consumption profiles lined up with due consideration to the seasonal fluctuations calculated from the measurements. The seasonal distribution can be approximately depicted by a sinus curve. Accordingly, maximum consumption occurs in the months of February/March and minimum consumption in the months of July/August. These seasonal fluctuations (up to around 20% is common) can be explained in principle by the holiday season and the lower hot water temperatures required in summer due to the high outside temperatures.

These aspects now have to be taken into consideration both with regard to the design of the solar thermal systems and the overall domestic hot water plants. Solar thermal systems are generally designed so that in the summer months with higher irradiation and slightly reduced consumption no surpluses are attained. In designing complete domestic hot water plants, on the other hand, the peak load is given priority to guarantee security of supply. Details of the dimensioning can be found in Section 8.

5.2

Determining heating requirements

Apart from domestic hot water, the second largest source of consumption in multi-storey residential buildings is heating energy. As shown in Figure 14, heating is required in Austria in the months from September to May (around 5,000 operating hours). If the period of solar radiation is compared with this demand period then it is apparent that the two do not correspond. The months with the lowest amount of sunshine have the highest heating demand.

Nevertheless, solar thermal systems in multi-storey residential buildings can make a considerable contribution towards covering heating demand particularly in the transitional period. If solar thermal systems in multi-storey residential buildings are also to be used to support the heating system then the heating requirements of the building need to be known for dimensioning the system.

The heating requirements indicate the amount of heat, calculated on the basis of a long-term mean value, which has to be supplied to the rooms of the building during a heating season to ensure that a given inside temperature can be maintained. The heating requirements of a building are normally calculated on the basis of ÖNORM EN 832.

$$\boxed{\phantom{Q_{HW}}} \quad [\text{kWh/a}] \quad \text{Equation 5}$$

Q_{HW} Annual heating requirements in kWh/a

Q_T Transmission heat losses in the heating period in kWh/a

Q_V Ventilation heating losses in the heating period in kWh/a

Q_i Internal heating gains in the heating period in kWh/a

Q_s Solar heating gains through transparent components in the heating period in kWh/a

η Utilisation factor for heating gain

The monthly heat requirements are calculated using the long-term average monthly values for the outside temperature at the site of the house, the length of the month and the specific transmission losses. The solar gains and energy sources from internal heat sources are subtracted from this. Following these two steps, the theoretical heating requirements of the house with an ideal control system are determined (ÖNORM EN 832, 1998).

The computer-supported calculation program OIB (OIB, 1999) is the program most widely used in Austria for the calculation of heating requirements and is characterised by the convenience of calculating the heating requirements and the heating load.

Similar to the preparation of domestic hot water, the peak load which occurs in the supply of space heat (heating load) is not the decisive value for dimensioning the solar thermal system. The heating load in a building is required to dimension the conventional heat generator or the heat output. This is available in any case as an intermediate or additional result of the calculation of heating requirements. The standard which has served as the basis for this calculation since March 2004 is ÖNORM EN 12831.

6

Structural Integration of Solar Thermal Systems in Multi-Storey Residential Buildings

The structural integration of solar energy systems plays a key role in the broad-based implementation of solar-supported heat supply systems in multi-storey residential buildings. The issue here is to find a common denominator for the architectural, energy efficiency and economic parameters. Although this applies primarily to the integration of the collectors, consideration also has to be given to the integration of the heat storage units and other components.

Architecture and aesthetics

Until recently, the topic of solar energy systems was primarily addressed by energy engineers, who did not always manage to make people sufficiently aware of the many ways systems could be integrated into buildings. A glance at the technological development of solar energy systems over the past few years shows, however, that the most innovative developments occurred in the field of structural integration. The structural integration of solar energy systems now covers a broad spectrum of possibilities that can range from completely unnoticeable installations to elements that contribute to the building's overall design. Assimilation with the building's envelope (roof and facade integration), flexible building designs, prefabricated unit construction and flexible colour scheme are a few examples of what is understood by the term structural integration today.

Energy efficiency

Solar energy systems generate heat and should therefore be constructed in such a way that they can operate at top performance. This should also apply to structural integration (inclination, direction and shade-coverage of the collectors). Numerous studies over the past several years have shown that tolerances in the case of deviations from the energetic optimum frequently result in only minor reductions in output and therefore do not pose a risk to profitable operation. To ensure that solar energy systems can be introduced on a broad front, energy engineers should take advantage of this considerable leeway and work together with the architects and clients to exploit the repertoire of modern structural integration.

Economic efficiency

To ensure that investment costs can be reduced by the maximum amount, all potential synergies have to be exploited. In the case of the innovative structural integration of collectors, this means that areas should be put to double use, for example by aiming to achieve savings in conventional surfaces, component layers, supporting structures, shading facilities etc. In addition, this could also reduce transmission heat losses and the amount of assembly work required.

6.1

Roof integration of solar collectors

The most common form of structural integration for solar collectors is roof integration. It involves mounting the collector on top of the existing supporting structure so that the collector also provides protection from the elements. Assembly with the help of cranes is the standard method used for industrially manufactured large-area collectors (Figure 20). In some projects, prefabrication and cost reductions have already been made to the extent that roofing elements assembled at the plant (consisting of supporting structures, heat insulation and collector) only have to be moved to their proper location at the construction site (Figure 21). The hydraulic connection of the individual large-area collectors and the installation of the main lines are carried out in the attic, which is protected against the weather.



Figure 20: Crain assembly of large-area collectors (picture source: S.O.L.I.D., Styria, Austria).



Figure 21: Crain assembly of the entire roof elements with support construction and collector field (picture source: Wagner & Co, Germany).

Roof-integrated collectors provide reliable protection from the elements and have standardised connections to the conventional part of the roof. In order to reduce the number of interfaces, most solar energy companies also offer weatherproof connection to the conventional part of the roof (all-round sheet metal covering). To ensure that investment costs are as low as possible, individual small collector surfaces are not used in practice for large solar energy systems. Instead, an attempt is always made to cover the largest contiguous surface possible with collectors. In practice, a particularly cost-efficient solution is to build roofs consisting solely of collectors (see Figures 22 to 25).

A basic principle here during the building planning phase is to ensure that none of the building's openings (for chimneys, ventilation shafts etc.) penetrate the south-facing roof surface. Although solar energy companies offer special variable formats for collectors, the least expensive solution is to take such things into account during planning of the building.



Figure 22: It is aimed to accomplish a roof consisting solely of collectors to buildings in multi-storey residential (picture source: S.O.L.I.D., Styria, Austria).



Figure 23: It is also possible to adjust the collector area to the form of the roof (picture source: Teufel & Schwarz, Tyrol, Austria).



Figure 24: Solar collectors can be adjusted to existing geometrical building constructions (picture source: AEE INTEC).



Figure 25: South orientated roof construction totally covered with collector area (picture source: Teufel & Schwarz, Tyrol, Austria).

6.2

Collector assembly with frame structures

For cost reasons, on-roof collectors are rarely mounted on new buildings with sloped roofs. The multi-storey, flat-roofed residential buildings extremely common in urban areas offer much greater potential for erecting on-roof collectors. Compared to roof-integrated collectors, on-roof collectors are exposed to wind and weather on all sides, thus requiring an appropriate collector structure. As far as costs go, there is no great difference between on-roof and roof-integrated collectors. The main difference is in the costs of the collector support structure and the weatherproof installation of the connecting lines. Figures 26 and 27 depict actual examples of frames used for solar collectors on flat roofs.



Figure 26: Three rows of collector area placed on a part of the building with flat roof (picture source: S.O.L.I.D., Styria, Austria).



Figure 27: The entire collector area mounted on the building roof with the shortest possible way to the heating unit transfer station (picture source: Solution Solartechnik, Upper Austria, Austria).

The appropriate wind loads have to be taken into account when measuring and installing the frames and the mountings. While only suction forces have to be taken into account for roof-integrated collectors, collectors that are set up in the open are subject to wind forces (suction wind and wind pressure) from all directions. Extensive calculations of wind loads and of the static requirements can be found in the publication titled "Große Solaranlagen – Einstieg in Planung und Praxis" (Remmers, 1999). As shown in Figures 28 to 32, in practice structural engineers and solar technology companies use different mounting techniques.



Figure 28: Each support construction break through the sealing surface of the flat roof. Because of many breakthroughs and thereby a higher risk for leakage should this mounting technique be avoided (picture source: AEE INTEC).



Figure 29: Large-area collectors mounted with a continuous construction. The construction is fixed on the roof on only a few places and the breakthroughs to the roof can thereby be reduced discontinuity (picture source: AKS DOMA Solartechnik, Vorarlberg, Austria).



Figure 30: The collector construction is mounted on two rows of concrete foundation with a dead-load of the structure accordingly. This way the roof must not be broken through, but the static dimension of the roof has to take the weight of the concrete into account (picture source: AEE INTEC).

If the collector is connected directly to the flat roof structure (Figures 28 and 29), the number of penetrations in the sealing surface should be kept to a minimum. Penetrations in the sealing surface increase installation costs while also increasing the risk of leaks. Another form of wind-proof collector installation is the use of foundations with a high dead weight (Figures 30 and 31). Concrete bases are generally used for this purpose. These bases are lifted onto the flat roof by means of a crane, and they serve as the foundation for the collector mountings. Although this ensures that no penetrations are made in the roof's sealing surface, the roof structure has to withstand the additional load. If weather protection is generally provided by a sheet metal roof (as is frequently the case in some regions of Austria), appropriate clamping profiles can be used to mount the collector frame to the standing seam (see Figure 32).



Figure 31: The collector construction is mounted on diagonal arranged concrete foundations with a dead-load of the structure accordingly. This way the roof must not be broken through, but the static dimension of the roof has to take the weight of the concrete into account (picture source: AEE INTEC).

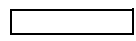

Figure 32: Clamping profiles mount the collector frame to the standing seam (picture source: Solution Solartechnik, Upper Austria, Austria).

In addition to numerous advantages and disadvantages, the various mounting possibilities do have something in common: The requirements (with regard to statics, sealing issues etc.) have to be

defined in close cooperation with the participating planners (architects, structural engineers etc.) and then used as a basis for solutions.

Another important issue when installing solar collectors on flat-roof frames on multi-storey residential buildings is that several rows of collectors might shade each other. The inclination angle of the solar collectors should always be determined in accordance with how the solar heat is used (domestic hot water or heating support). Possible reasons which prevent the energetically optimal inclination angle from being used are the desire that the collectors not be visible from the ground and a lack of space to ensure a shade-free installation of the collectors. Collectors with a small inclination angle or a low construction height produce shorter shadows, thus allowing the distance between the rows to be reduced (see Figure 33). The lowest elevation of the sun (21 December) should be taken into account when measuring the distance between the rows.

 [m] *Equation 6*

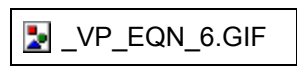
 [m] *Equation 7*

- D Distance between the rows of collectors [m]
- L Collector length [m]
- H Collector height [m]
- α Collector inclination angle [°]
- ε Insolation angle [°]

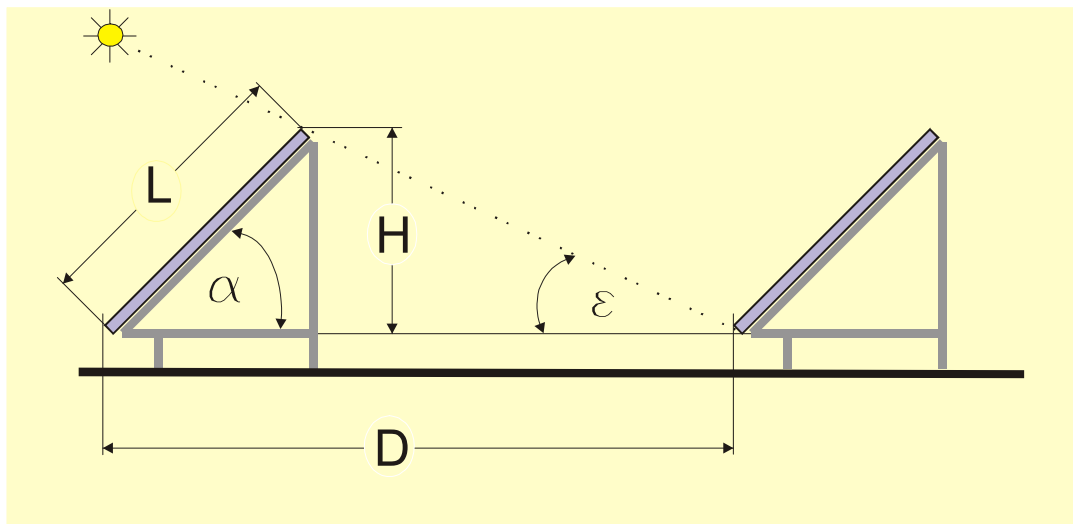

Figure 33: Variables influencing the distance, D between the assembly rows.

6.3

Facade integration of solar collectors

The material that has had the most influence on architecture over the past few years is glass. The transparency of this material allows interior and exterior areas to merge and produces a feeling of spaciousness and openness. As a result, glass technology has made major advances with regard to

statics, heat insulation and light transmission and the price has fallen thanks to increased production volumes.

Solar technology has the potential to influence facades to the same degree over the next decade. Existing examples have created quite a stir and have received numerous awards.

Whereas the development of inclined collectors has moved towards optimum roof integration, facade collectors are now clearly becoming a part of the outer shell of a building and influencing its design (Figures 34 and 35).



Figure 34: The façade integrated collector area has become increasingly important in the recent years (picture source: AKS DOMA Solartechnik, Vorarlberg, Austria).



Figure 35: Results from research projects and product development have also made façade collectors interesting for multi-storey residential buildings (picture source: Holleis Solartechnik, Salzburg).

When used in multi-storey residential buildings, facade collectors have a lower energy yield than inclined collector surfaces. Despite this, facade collectors offer some interesting economic possibilities.

Facade-integrated solar collectors do not necessarily have to be back-ventilated, but, depending on the specific conditions, can instead be mounted directly on the exterior wall.

In this way, a facade collector that is not back-ventilated vastly improves resource and energy efficiency by exploiting synergy effects with the exterior wall. This applies particularly to multi-storey residential buildings because of the comparatively large surface areas that are affected. The main functions of a facade collector that is not back-ventilated are:

- Serving as a solar collector
- Improving the building's heat insulation
- Serving as a passive solar element when there is little sunlight (collector without any flow)
- Collector glazing provides weather protection for the facade
- Influencing the design of the facade
- Noise protection

As a result, the main advantages of facade-integrated collectors that are not back-ventilated are:

- Reduction of transmission heat losses
- Cost reduction through the joint use of components
- Replacing the conventional facade and providing an additional function by producing energy in its role as a thermal solar collector
- No maintenance such as painting or patching of the plaster required
- Suitable for new buildings as well as for renovated structures

The following summary of the required structural conditions is taken from the results of a comprehensive research project (Müller et al., 2004).

6.3.1

Heat and moisture transport through wall structures

In principle, exterior walls and roof structures have to adhere to the relevant standards and building codes with regard to heat, moisture and noise protection.

Unlike back-ventilated facade collectors (moisture can be removed through the back ventilated layer) the collector insulation in collectors that are not back-ventilated is also part of the wall insulation, i.e. the collector is an integrated part of the whole exterior wall system (Figure 36).

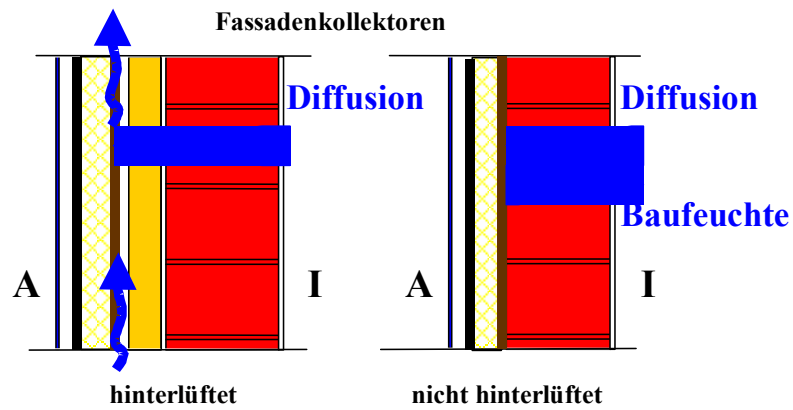

Figure 36: Moist diffusion in wall constructions with back-ventilated and not back-ventilated façade collectors.



Figure 37: Façade collectors without back-ventilation in a terraced house in Graz, Austria. The collector is statically an independent element with the backboard serving as reinforcement (picture source: AKS DOMA Solartechnik, Vorarlberg, Austria).



Figure 38: Mounting of a prefabricated outer wall with façade collectors without back-ventilation: the collector is not statically independent, but serves as a part of the outer wall construction (picture source: AKS DOMA Solartechnik, Vorarlberg, Austria).

If a non-back-ventilated collector is placed on the wall exterior, the requirements valid for conventional exterior walls (that the wall structure permits diffusion to the outside) can no longer be fully complied with. In this case, moisture transport and therefore the drying of the material must take place towards the inside. Building physicists have to take this into account when planning non-back-ventilated facade collectors.

Moisture accumulation in the exterior wall can have various causes. Particularly in the case of masonry wall constructions, these accumulations can be caused by building moisture during the first few months of construction. In addition, these accumulations can be caused by moisture intruding from inside or outside the building.

While structural measures can be used to prevent moisture (such as rain) from entering the wall from outside the building or at least keep such intrusions to a minimum, special attention should be paid to diffusion and air flows in order to prevent moisture from entering from inside the building.

Because the materials used for the collector on the cold exterior of a wall are relatively vapour retarding, water vapour can only be removed to the outside to a limited extent. Similar to the situation with composite heat insulation systems, the wall must therefore mainly dry out towards the inside. Condensation within the component interiors is particularly harmful when the condensation water cannot be stored and released, when the construction materials are damaged by the condensation water or when the accumulated condensation water does not fully dry out in summer.

On the basis of extensive calculations and measurements of the moisture balance of various types of wall structures with facade collectors, it is possible to make the following planning recommendations. However, these recommendations cannot replace the inspections of the final structure by an expert planner (building physicist) (Müller et al., 2004).

- Since most of the moisture is dissipated to the interior when non-back-ventilated collectors are used, there should not be any excessive building moisture in the structure when the occupants move in. Attention should particularly be paid to this when dealing with reinforced concrete and wooden exterior walls.
- On the basis of numerical calculations, condensation water can be expected to accumulate at times in the air gap between the collector and the heat insulation in structures made of reinforced concrete or lime-sand bricks. In such cases, it is recommended that, at the very least, an expansion layer or a non-vapour retarding separation layer be used. Plans have to take into account the need to ensure appropriate drainage of any non-harmful condensation water.
- Impermeable surface materials, such as tiles, should not be used on the inside if possible, since this prevents or slows down the drying of the structure toward the inside.
- When statically independent collectors are placed in front of vapour-retarding rear walls (e. g. those made of aluminium) condensation water sometimes accumulates between the collectors and the heat insulation. Because this moisture dries out in summer, it generally is not harmful. Care should be taken, however, that the adjacent components and materials are not damaged.
- It must be ensured that exterior wall structures — particularly in the case of lightweight wooden structures — are airtight on the hot side. In the case of lightweight wooden structures, thin vapour retarders should be preferred to thick vapour barriers since the structure will otherwise be initially subject to high humidity levels. This also applies to brick buildings with open vertical joints.

Reduction of the effective U-value of the outside wall

A non-back-ventilated facade collector is even beneficial when the facility is not in operation, serving as a so-called passive element. Even when the insolation is low, temperatures at the absorber are higher than in the surrounding area. This reduces the transmission heat losses on the section of the wall with a collector, a fact that is expressed in a reduction of the effective U-value. This U-value, which is calculated on the basis of the actual values for the heat flow and the inside and outside temperatures, is designated as the effective U-value (U_{eff}).

Unlike the static U-value, the effective U-value is not constant, as it is dependent on the prevailing conditions, such as the intensity of the solar radiation and the inside and outside temperatures. If a non-back-ventilated collector in the facade is heated up, the effective U-value drops and the need for heating is consequently reduced.



Figure 39: The effective U-value of the outer wall is reduced with the application of non back-ventilated façade collectors (picture source: SIKO Energiesysteme, Tyrol, Austria).

Extensive studies (Müller et al., 2004) have shown that on a sunny winter's day the U_{eff} -value can be reduced by up to 90 percent through the use of selectively coated absorbers and by up to 85 percent when non-selective absorbers are used. In fact, the U_{eff} can still be reduced by up to 50 percent for selective absorbers and up to 35 percent for non-selective absorbers even on bad-weather days when insolation is low.

This clearly shows that built-in facade collectors can bring about a substantial reduction in heat losses. On sunny days, the heating of the collector can also lead to a heat flow into the room, which counts as a further energy gain.

6.3.3

Coloured absorber layers

It became apparent during discussions with architects that they see a need for coloured absorbers before facade collectors can be used on a wide scale (Stadler et al., 2002). Architects demand the same of thermal solar collectors as they do of any other building component, i.e. that it be suitable for use as an architectural design feature.

As a result, the absorbers need colour coatings with nearly the same performance as the mostly black coatings already available on the market. This requirement is understandable considering that reductions in absorber performance lead to larger collector surfaces and consequently to higher costs.

Up to now, colour collectors have consisted merely of absorbers covered with conventional temperature-resistant paint. However, these coatings do not achieve the same performance level as conventional collectors.



Figure 40: Different colours are available for efficient absorber layers (picture source: AEE INTEC).



Figure 41: Application of coloured absorber layers in multi-storey residential buildings (picture source: Teufel & Schwarz, Tyrol, Austria).

Recent research results have shown that special coating techniques would also allow the production of colour absorber layers that have the same level of efficiency as black solar paint coatings.

Integration of energy storage units in buildings

The size, location and geometric shape of energy storage units have a large influence on the energy efficiency of the overall system. To keep heat losses (see Section 9) and capital costs to a minimum, the energy storage units should, if at all possible, consist of a single container. For energy reasons, they should also be placed within the building if possible. This ensures that the heat losses that occur despite the very best heat insulation are directed into the building. Because of the typical geometrical shape of storage units for multi-storey residential buildings (see Figure 42) the usual room heights and inside door widths are insufficient to allow a single energy storage unit to be appropriately integrated into the building after the structure is completed.

For this reason it is necessary that:

- The exact location of the energy storage unit (a central location should be chosen to ensure short pipe lengths) is already laid down during the planning phase. In general, this should also take into account settling of the foundation slab in this area.
- The energy storage unit should be installed into the building in line with the progress of construction (prior to the completion of the basement ceiling). The surfaces of the energy storage unit should be adequately protected against damage and corrosion during construction work.



Figure 42: Energy storage tanks in multi-storey residential buildings have already to be integrated in the planning phase due to their size and position (picture source: AEE INTEC).



Figure 43: The energy storage tank is as standard lowered into the foundation and installed prior to the construction of the basement ceiling (picture source: AEE INTEC).

The insulation of the storage unit has to be taken into account when defining the required room height. In the upper storage area, this should have a thickness of around 300 mm. In the outer casing there has to be enough space toward the walls for an insulating layer at least 200 mm thick (plus the required space for the proper mounting of the device).

Whilst energy storage units should always be located within buildings for energy reasons, their placement also can serve as a design feature for architects. Various architects have used heat stores in the past as visible design features for displaying innovative heat supply systems and the use of renewable sources of energy (Figures 44 and 45). Although the resulting increase in heat loss can be almost completely offset by using correspondingly thicker insulation materials, the need for secure long-term weather protection leads to higher capital costs.



Figure 44: Energy storage tank integrated deliberately visible in the building (picture source: AEE INTEC).



Figure 45: Part of the 100 m³ energy storage tank appears from the underground in the middle of the housing estate Gneis-Moos (picture source: AEE INTEC).

System Hydraulics

The choice and design of system hydraulics has a major effect on ensuring satisfactory operation while requiring as little supplementary heating energy and maintenance as possible. For this reason, it is recommended that great care be taken during this planning phase and that the system hydraulics selected is adapted to the specific requirements. A large number of different hydraulic concepts are available, depending on the application (consumers, consumption profiles, type of conventional heat generator, geometrical boundary conditions, etc.) and the system size. These concepts are described in detail in the following sections, thus simplifying the selection of the most favourable system hydraulics.

This section begins with a description of the requirements and conditions that apply equally to all applications of solar-supported heat supply systems.

7.1

Basic information about solar-supported heat supply systems

7.1.1

Domestic water temperature and water hygiene – legionella bacteria

When defining the temperature of domestic water, the primary concern must be user comfort. As a result, the minimum temperature at the tap should not drop below 45°C to ensure it is still usable. On the other hand, domestic water temperature must not exceed 60°C in order to prevent scalding, lime scale and corrosion, and to keep heat losses to a minimum. In addition to the aspects mentioned above, hygienic requirements also have to be taken into account.

The most common bacteria in drinking water are the so-called legionella. These bacteria are difficult to detect and they occur naturally in all types of fresh water. Healthy people are only rarely infected, however, and this is generally only possible by inhaling small droplets of legionella-contaminated water. In contrast, drinking this water is not harmful. It is very difficult to determine what kind of a threat legionella pose, since it is not known whether there is a minimum infective dose and there are, as a result, no clear threshold or guideline values.

Legionella growth is dependent on the water temperature, the surrounding materials (iron promotes growth while copper hinders it), the bacterial culture medium and the water's pH value. The optimum growth temperature is between 30 and 45°C. Temperatures of at least 55°C cause the bacteria to die off completely, provided they are subjected to this temperature for long enough. In addition to thermal disinfection, chemical and UV disinfection can also be employed. Thermal disinfection is now the most commonly used method for domestic water heating systems.

In order to minimise the risk of Legionnaires' disease breaking out, the German Technical and Scientific Association on Gas and Water (DVGW) has drawn up a corresponding set of regulations (Worksheet W551 for new systems and Worksheet W552 for existing systems). The information is summarised in Table 2. Austria has no comparable guidelines concerning legionella.

In general, it should be noted that legionella are not a problem affecting only solar-supported heat supply systems for domestic water, but all conventional domestic water heating systems as well.

This is made clear in the DVGW worksheets, which state that multi-storey residential buildings equipped with central heat supply systems for domestic water should be fitted with appropriate hydraulic and thermal systems since even if the domestic water store has a capacity of ≤ 400 l, the hot water distribution system with the circulation line certainly has a capacity of > 3 l.

According to the DVGW, special measures are not required for systems with decentralised heating of domestic water (small domestic water stores or continuous flow water heaters). From their very nature, such individual apartment units therefore have certain hygienic and thermal advantages.

7.1.2

Important characteristics for solar-supported heat supply systems

Various characteristics are used to assess and compare solar energy systems and heat supply systems. In addition to characteristics that only describe the solar energy system, it is recommended that characteristics which provide meaningful information on the quality of the overall solar-supported heat supply system also be used. In the following sections, definitions will be provided of the "degree of solar coverage", the "specific yield" and the "annual degree of system utilisation". To ensure that the reference quantities and energy flows can be clearly assigned, the essential parameters are entered in Figure 47 in accordance with their definition and their "position within the system".



Figure 46: Modern solar-supported heat supply systems combine the hydraulic concepts with hygienic harmless in high energy efficiency (picture source: AKS DOMA, Vorarlberg, Austria).

7.1.2.1

The degree of solar coverage (SD)

The most commonly used value for assessing thermal solar energy systems is the degree of solar coverage, which describes how much of the energy provided is supplied by the solar energy systems. However, there is no uniform mathematical definition of the degree of solar coverage. In the literature

and commercial simulation programs, this value is computed on the basis of different equations, which sometimes lead to very different results.

Domestic water heater	Minimum thermal requirements
Domestic water heater $\leq 400\text{l}$ and pipe contents from the heater $\leq 3\text{l}$	None
Domestic water heater $> 400\text{l}$ and pipe contents from the heater $\leq 3\text{l}$	Temperature upon exiting the domestic water storage tank $\geq 60^\circ\text{C}$
Domestic water heater $\leq 400\text{l}$ and pipe contents from the heater $> 3\text{l}$	The entire preheating system must be heated up once a day (for a domestic water storage tank) to $\geq 60^\circ\text{C}$
Domestic water heater $> 400\text{l}$ and pipe contents from the heater $> 3\text{l}$	Return temperature of any circulation lines $\geq 55^\circ\text{C}$

Table 2: Requirements for domestic water heating systems according to the DVGW worksheets (W551 and W552)

According to the usual definition, which is also used in this publication, the losses to collectible energy (energy supplied to the consumer) are added when computing the degree of solar coverage. It is defined as follows:

Equation 8:

 _VP_EQN_7.GIF

[%]

Q_{solar} annual heat input to the solar heating system in kWh, as measured on the secondary side of the solar energy circuit.

$Q_{\text{konv We}}$ annual heat input to the conventional heat generator in kWh, as measured between the heat storage unit and the conventional heat generator.

The energy quantities (solar energy and supplementary heating energy considered here are defined as inputs into the storage unit and are measured before entering it. This means that all system losses (storage losses, heat distribution losses etc.) are taken into account starting from the storage unit. However, this does not include supply line losses in the solar energy circuit or the provision of supplementary energy. The reference period is usually one year. However, if needed, it can be calculated for any length of time desired.

The specific solar energy yield (SE)

The specific solar energy yield describes the annual amount of energy supplied to the heat storage unit from one square metre of collector surface. The gross collector surface area is used to compute the specific solar energy yield. Compared to other calculation results, the kind of surface (absorber, aperture or gross collector area) the specific yield refers to must always be indicated (see Figure 47). The reference period is usually one year. However, if needed, it can be calculated for any length of time desired.

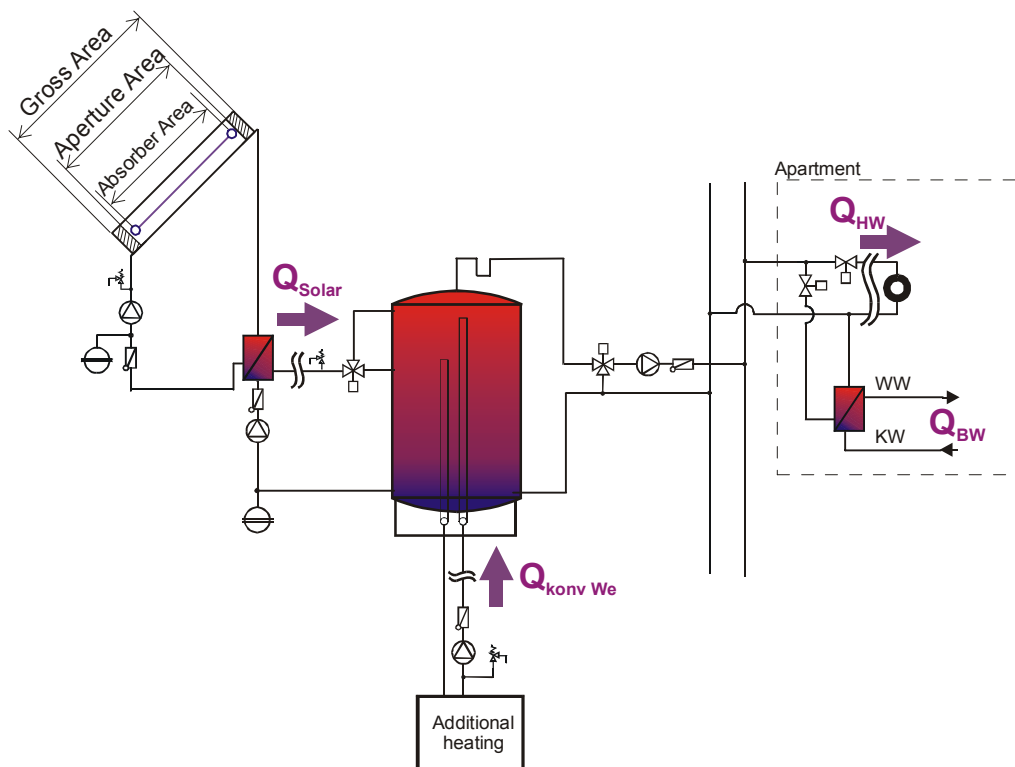

Figure 47: Allocation of the heat flow and reference values in the solar thermal system.

Equation 9:

$$\boxed{\text{Image Icon}} \text{_VP_EQN_8.GIF} \quad [\text{kWh/m}^2\text{a}]$$

Q_{solar} annual heat input to the solar energy system in kWh

$A_{Bruttokollef}$ gross collector area in m^2

The specific solar energy yield is often said to be the crucial parameter for measuring the capacity of a solar energy system. For a correct interpretation of this parameter, the size of this system (i.e. its degree of solar coverage) and the system losses (storage and heat distribution losses) have to be taken into account.

7.1.2.3

The annual degree of system utilisation (S_{Nutz})

Systems for providing domestic hot water and heating display losses from the heat generation stage all the way to the actual consumer (residents' demand for domestic hot water and also the heat emission from the systems). These losses must be taken into consideration when evaluating the system designs. The efficiency of the overall solar-supported heat supply system can be described by using the annual degree of system utilisation. The annual degree of system utilisation is generally defined as output divided by input. The output is defined as the amount of energy supplied at the point of use (taps for domestic hot water as well as heat emission systems). The input is defined as all the heat quantities (from solar energy systems and conventional heat generators) that are supplied to the heat storage unit. The value therefore has the following definition:

Equation 10:

 _VP_EQN_9.GIF

 [%]

Q_{HW} Annual heating demand of the residential units in kWh

Q_{BW} Annual domestic water demand of the residential units in kWh

$Q_{\text{konv We}}$ Annual heat input of the conventional heat generator in kWh

Q_{solar} Annual heat input of the solar energy system in kWh

7.1.3

Low-flow systems for solar energy facilities in multi-storey buildings — speed control and loading strategies

7.1.3.1

Low-flow vs. high-flow systems

Large thermal solar energy systems should always be operated in accordance with the low-flow principle. This covers specific collector mass flow rates of approx. 5 – 20 kg/m²h. Compared to high flow systems (21 – 70 kg/m²h), which should only be used for small systems (solar energy systems in single-family homes), this results in a far higher temperature increase per collector cycle. Whereas the storage temperature is slightly increased during each collector cycle of a high-flow system (assuming that the intensity of solar radiation remains unchanged), low-flow systems can achieve their useful temperature (65 °C, for example) in a single collector cycle. To ensure that this high temperature level is made directly available to the consumer (without any intermixing if possible) the heat storage unit must be charged with heat at the appropriate temperature.



Figure 48: Solar thermal system in a multi-storey residential building should be operated through the low-flow principle (picture source: AEE INTEC).

If the appropriate hydraulic system and correctly sized system components are used, low-flow solar energy system operation in multi-storey buildings can result in the following benefits:

- Because of their relatively low volume flows, low-flow systems require substantially smaller pipe dimensions for the supply lines (feed and return) and therefore result in lower capital costs.
- Compared to high-flow systems, low-flow systems require and also enable long thermal lengths in the collector interconnection (long series connections). For this reason, serial fields measuring up to about 80 m² (in special cases up to 100 m²) of collector area can be flowed through, depending on the absorber geometries and the related drop in pressure. The amount of pipework required is therefore substantially reduced, as only a single feed point to each of the main lines (feed and return) is necessary for the entire field. In comparison, the limit for series flow collector area in high-flow systems is between 20 and 25 m², depending on the absorber geometries and the related drop in pressure. This advantage of low-flow systems substantially reduces not only the amount of hardware (pipes, insulation) needed, but also the amount of assembly work and therefore also the capital costs.
- Compared to high-flow systems, the reduction in the amount of pipework required and the substantially smaller diameter of the remaining pipes significantly reduces the heat losses and therefore substantially increases the annual degree of system utilisation.
- Because of the reduced volumetric flow rate, a substantially lower hydraulic pumping power is required and therefore also a lower electric pump power.
- Because the useful temperature is quickly reached, the need for supplementary heating is reduced in correctly dimensioned and operated low-flow systems.

Table 3 depicts the range of specific mass flow rates of the various operating modes of the solar installations and the differences in the total mass flow rate in the feed and return piping of an assumed collector area of 200 m². This example shows that large manifold cross-sections and electric pump power ratings are required when the high-flow operating mode is used in large-scale solar energy systems. The costs of installing and operating the system would therefore soon exceed acceptable limits.

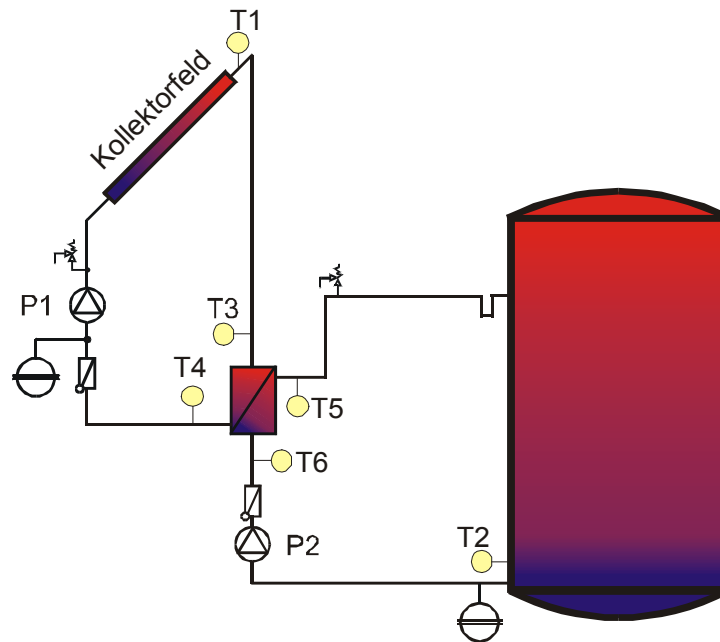

Figure 49: Allocation of the temperature sensors corresponding to the speed control criteria of the primary and secondary pump, listed in table 4.

Note that this allows the system's efficiency to be increased even though the capital costs remain practically unchanged (most of the sensors are in any case needed for automated functional checks). The criteria for a possible speed control system are shown in Table 4.

$T1 > (T2 + 7K) \Rightarrow$ P1 On (max. speed)

7K because it is assumed that the heat exchanger's temperature difference rating is 5K and the heat losses of the primary circuit's feed piping are 2K.

$T3 > (T2 + 5K) \Rightarrow$ P2 On (max. speed)

5K because the heat exchanger's temperature difference rating is assumed to be 5K

Speed control of P2 at 65°C to T5

Speed control of P1 at a nearly constant ΔT (between T5 and T6 or T3 and T4)

Speed reduction of P1 and P2 to a max. of 25% of the rated speed

Table 4: Sample criteria for the speed control of the primary and secondary circuits of a solar energy system



Figure 50: Standard by the solar thermal systems in multi-storey residential buildings: crane mounting of the large area collectors (picture source: AEE INTEC (left), SIKO Energiesysteme, Tyrol, Austria (right)).

Frost protection shutoff switch for the secondary circuit of a solar energy system

If pumps P1 and P2 (see Figure 49) are not switched on at the same time, the secondary circuit of the heat exchanger (without antifreeze mixture) is in danger of freezing if the external temperature drops below 0°C and the system has very long exposed pipes. If the collector is warmer than the lower part of the storage unit, pump P1 is switched on regardless of the outside temperature. Especially in the case of very long exposed pipes, the temperature of the heat transfer medium between the collector and the heat exchanger can then drop below 0°C. This operating state does not pose a problem for the primary circuit, since the heat transfer medium contains sufficient amounts of antifreeze. However, if the heat transfer medium “plug” reaches the heat exchanger with temperatures below 0°C, the pure water contained in the heat exchanger’s secondary circuit might freeze and therefore damage the heat exchanger or the adjacent pipes. To prevent this from happening, a system equipped with such exposed pipes should have its secondary circuit pump switched on before reaching a temperature of +3°C at T3 (see Figure 49) as a precautionary measure. The disadvantage of a small amount of mixing in the heat storage unit is very minor compared to the costs resulting from the damage caused by frost.

7.1.4

Collector interconnections

In large-scale solar energy systems, the interconnection of the collectors is very important from both an energetic and an economic standpoint. The following aspects should therefore be taken into account as far as possible:

- The heat transfer between the absorber and the heat transfer medium should be made as efficient as possible by employing corresponding flow rates in the absorber pipe (turbulent flow)
- The pressure loss due to flow through the collectors should be as low as possible
- The geometric shapes of the collectors should be chosen on the basis of the areas on which they will be mounted (in order to reduce costs, large-scale collectors should be used that possess standard geometric shapes as defined by the manufacturers)
- There should be as little pipework as possible in order to reduce heat losses and the cost of materials and installation

Large-scale solar energy systems in particular have a much greater potential for minimizing collector interconnection costs (the cost of materials and installation) and reducing heat losses than do small-scale systems. This potential can be exploited by using large-area collectors and by intelligently interconnecting the individual collector components.

7.1.4.1

Large-area collectors

Large-area collectors are industrially prefabricated collector components that have a standard size of up to 12 m² (made-to-order components measuring up to 20 m² are available as well) and a finished internal hydraulic interconnection. Large-area collectors are generally installed directly by the manufacturer of the solar energy system using mobile cranes. The effort required to install the system is significantly reduced as a result. Experience has shown that an installation team (1 mobile crane, 4 installers) can install and hydraulically interconnect up to 300 m² of collector area per day when setting up roof-integrated large-area collectors. In the case of free-standing large-area collectors, the potential daily capacity including set-up and securing of the system against wind loads is approx. 100 m² of collector area. Figure 50 depicts the crane-supported installation of commercial large-area collectors.

7.1.4.2

Efficient collector pipework

It is mistakenly thought that a low-flow system can be created by simply operating a high-flow collector interconnection at a lower flow rate than usual in order to attain higher collector outlet temperatures. In many cases the fluidic conditions within the collector are ignored, which leads to unnecessary reductions in the yield of the solar energy systems. Characteristic features of low-flow interconnections are the long thermal lengths and the small number of parallel strings (adjusted to the geometric shape of the absorbers). In combination with the low specific mass flow rates typical of low-flow systems this results in a large temperature increase within the collector cycle and a largely turbulent flow.



Figure 51: Serial connection of large area collectors with internal connections reduces piping costs and heat losses, but favour the heat transmission (picture source: Teufel & Schwarz, Tyrol, Austria).

This is why low-flow systems are ideal for series connections of large-area collectors. Furthermore, they allow pipework to be kept to a minimum if the hydraulic systems are intelligently laid out. As mentioned in Section 7.1.3, serial fields measuring up to about 80 m² (up to 100 m² in the case of appropriate absorber pipe geometries) of collector area can be flowed through, depending on the absorber geometries and the related drop in pressure. The amount of pipework required is therefore substantially reduced, as only a single feed point to each of the main lines (feed and return) is necessary for the entire field.

In any event, care should be taken that even large-scale solar energy systems in multi-storey residential buildings do not experience pressure losses in their collector fields of more than 40,000 Pa (corresponding to 4 mWS). Pressure loss curves for individual collectors (different mass flow rates and corresponding heat transfer medium concentrations) to determine the loss in collector pressure can be ordered from the manufacturers.

Figure 52 depicts two different interconnection possibilities for a roof-integrated gross collector area of approx. 160 m² (a collector strip measuring approx. 40 m × 4 m and consisting of 16 large-area collectors each measuring 5 m × 2 m). To clarify the arrangement of the collector area, a sectional view is shown in Figure 53. The upper circuit diagram only consists of two parallel collector fields with 80 m² of gross collector area each. The advantage of this set-up is that only two connections at the feed and return pipe are needed for the entire interconnected system. The pipes that would otherwise be required for distribution can be dispensed with completely because the correspondingly defined internal interconnections are used for this purpose.

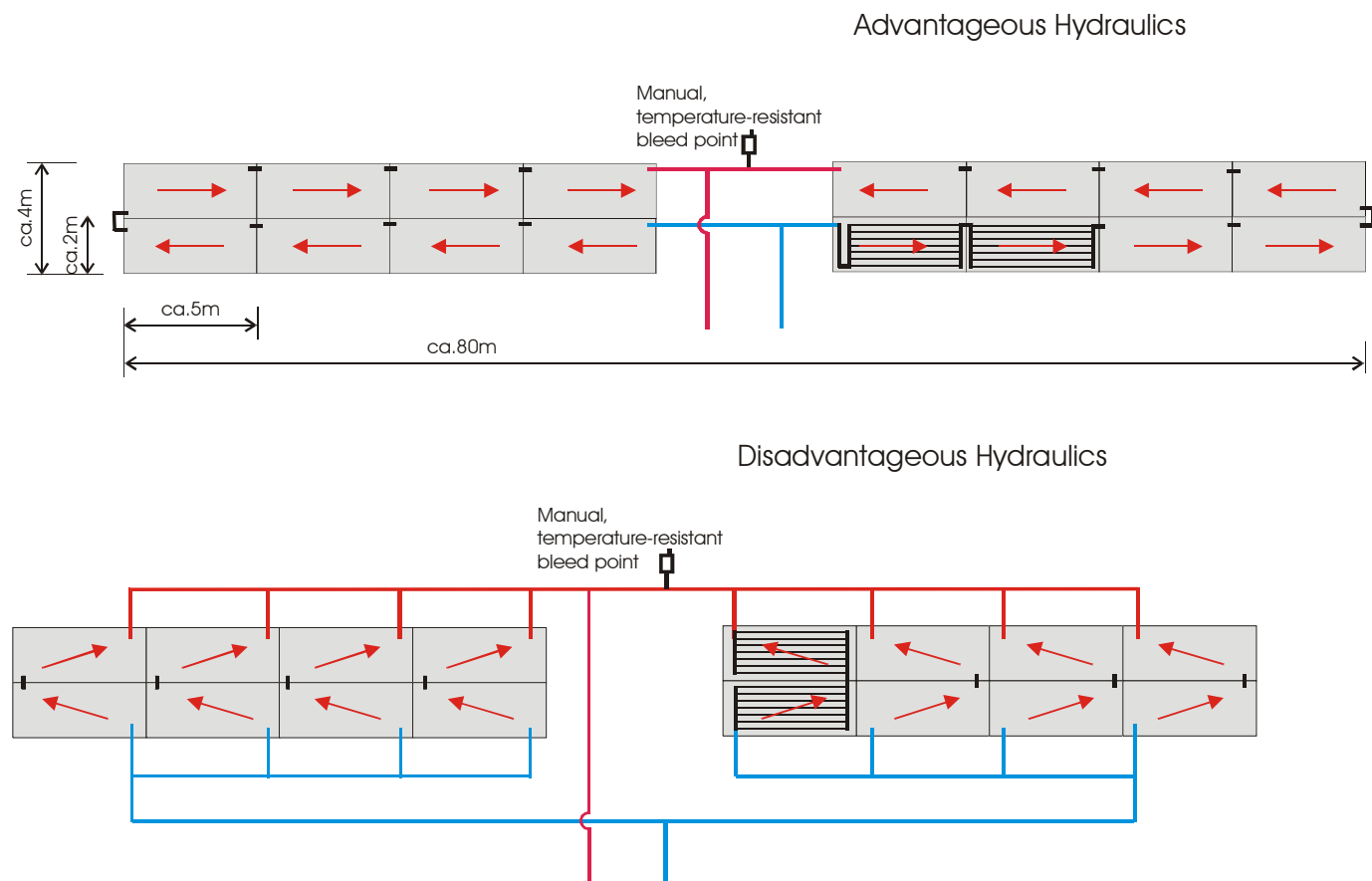

Figure 52: Two examples of collector interconnections for a roof integrated collector area with 160 m² gross area: there is hardly any need for pipe work in the upper hydraulic. The lower hydraulic need an additional 90 m pipe work.

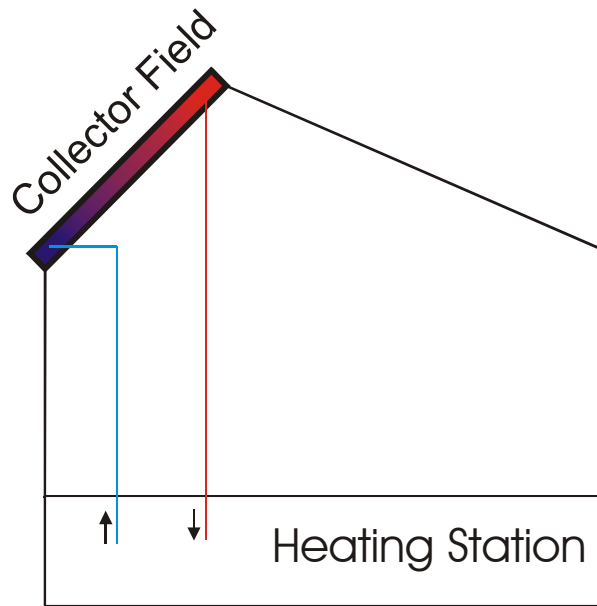

Figure 53: Cross-section of a collector assembly.

The lower hydraulic system shown in Figure 52 is an example of a comparatively disadvantageous type of interconnection. Designed for high-flow systems, this type of interconnection consists of eight parallel collector groups, each of which has approx. 20 m² of gross collector area. Each of these groups has to be independently connected to the feed and return pipes (manifolds). All in all, the lower variant of this example would lead to over 90 m of additional pipework. This would not only result in higher capital costs, but also produce far higher heat losses.

This applies not only to the roof integration of collectors, but also to flat-roof installations with support frames. A good example of a collector interconnection with frame-supported collectors is shown in Figures 54 and 55. By connecting individual large-area collectors in series, external pipework can be reduced in this example as well. It should be noted, however, that the feed point for the manifolds does not have to be located in the centre, but can instead be positioned on the front, depending on the location of the building services such as heating, ventilation, air-conditioning and plumbing areas.

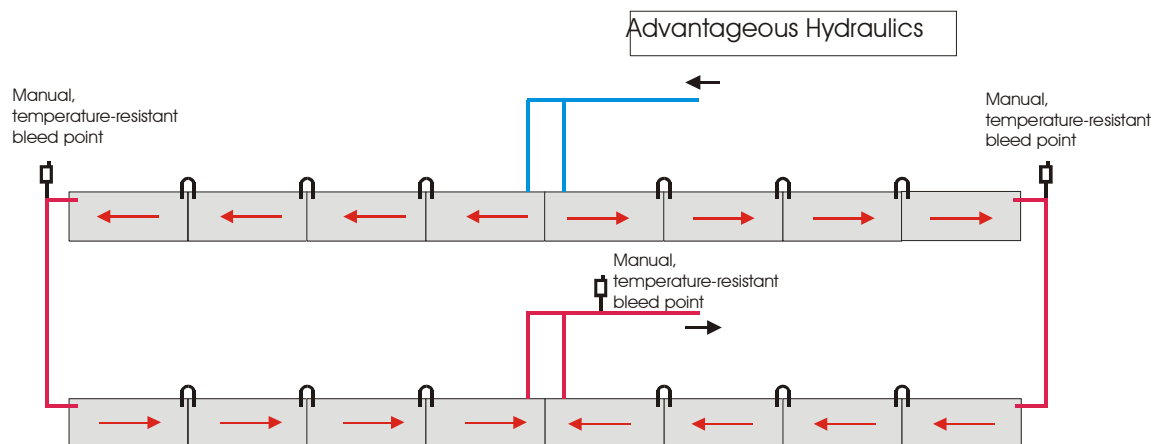

Figure 54: Example of collector interconnection for flat roof installations with 160 m² gross collector area: there is hardly need for pipe works because of the serial connection by big size collector area.

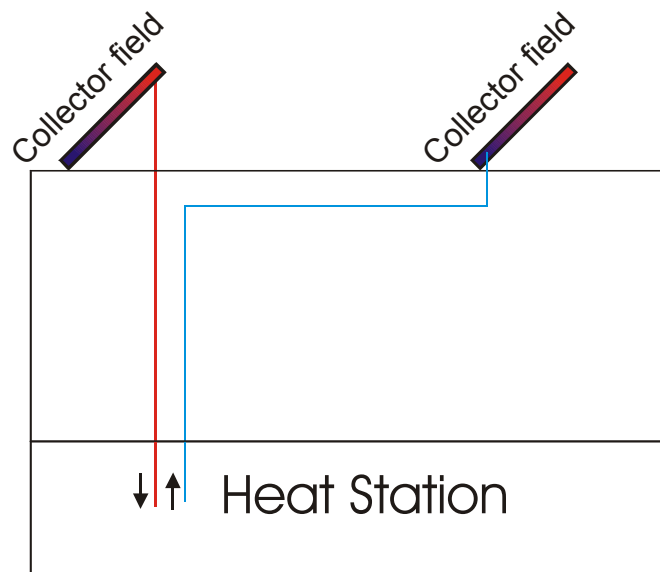

Figure 55: Cross-section of a collector assembly.

Unlike the situation with small-scale systems, it is recommended that Tichelmann-type collector interconnections should not be used for solar energy systems in multi-storey residential buildings. The Tichelmann principle is based on the concept that individual parallel groups are reached by uniform flows moving through the same hydraulic lengths of pipe. Even though this principle has proven to be successful in small-scale systems, it requires extensive lengths of balancing pipes when used in large systems and therefore results in considerable pipework costs and heat losses on the surface of the pipes. Instead large-scale solar energy systems achieve a uniform flow through parallel groups by using different cross-sections for the supply lines to the collector fields. This approach requires detailed calculations of the pipe network, which are normally conducted for large-scale solar energy systems anyway. Regulating valves are not recommended because stagnation in the collector area (pipes in the immediate vicinity of the collectors) can lead to temperatures of around 200 °C and corresponding temperature-resistant valves and fittings are very expensive.

7.1.4.3

Expansion compensation

An essential issue that has to be taken into account when interconnecting extensive serial lengths is longitudinal expansion as a result of temperature increases. Because stagnation can lead to temperatures of up to 200 °C in the collector area, room must be left for the linear expansion caused by a temperature difference of about 200 K. In the case of copper (the material most commonly used in collectors), such a difference in temperature causes a linear expansion of about 3.5 mm for each metre of pipe. If this is not taken into consideration, the result will inevitably be a burst pipe. Exactly how this linear expansion is counteracted in practice is shown by the recommended solutions in Figure 56.

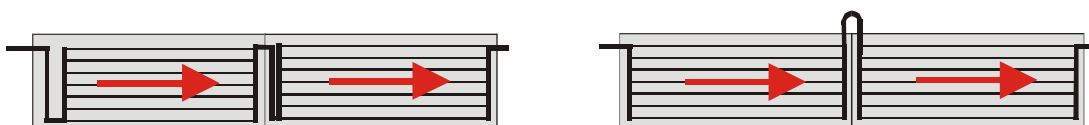

Figure 56: Expansion compensation for big size solar thermal systems in practice (left: expansion loop in the collector, right: external expansion loop with flexible pipes).

Although the collector's expansion loop (left in Figure 56) results in somewhat higher manufacturing costs, it not only compensates for linear expansion, it can also, due to the hydraulic loop, lead to more favourable behaviour in case of stagnation (see Section 7.1.5). External expansion loops (on the right in Figure 56) result in lower collector production costs and provide more leeway during installation. Disadvantages are the behaviour in case of stagnation and the location of the expansion loop when integrating the collector into a building. Because of the latter disadvantage, this interconnection/expansion compensation variant is most frequently used for freestanding collectors (on flat roofs, for example).

Because of these design measures, there is no need for valves and fittings designed to accommodate the expansion ("expansion compensators").

7.1.4.4

Bleeding and flushing

A key point that has to be taken into account with regard to collector pipework is the possibility of complete and problem-free bleeding of the system. Manual bleed points directly integrated into the pipe at raised points and with an appropriate air reservoir have proven themselves in practice. Because of their location in the proximity of the collector, these bleed points must be resistant to temperatures of at least 200°C. However, they must also be easily accessible and have heat insulation because of the direct flow. Figure 57 shows the arrangement of an appropriately weather-protected and heat-insulated manual bleed point.



Figure 57: Configuration of a temperature resistant, manual bleed points with weather-protection and heat-insulation (picture source: AEE INTEC).

The manual bleed points mounted in the collector area permit complete bleeding of the system. The number of manual bleed points required depends on the interconnection concept. However, not every

high point must be fitted with a bleed point. The arrangement of the bleed points in the collector has already been shown in Figures 52 and 54.

Because of possible losses of heat transfer medium in the event of stagnation and the typically short period in operation, automatic bleed points should generally not be used in the solar energy system's primary circuit. If automatic system bleeding is nevertheless desired, practice has shown that this is possible by fitting such a system in the engineering room in a bypass to the main string. The bypass string is open only while the system bleeding process is underway. In normal operation, the automatic bleed point is hydraulically cut off from the main string.

If several collector fields are arrayed in parallel, it is necessary that individual circuits can be cut off so that they can be flushed or fully bled. It should be noted that correspondingly temperature-resistant shut-off valves and fittings (up to at least 200°C) must be used and that it must not be possible to cut individual collector fields off from the safety valve. For safety reasons, it is definitely recommended that the hand levers or hand wheels on the shut-off valves and fittings be removed following the flushing of the system.

7.1.5

Stagnation behaviour of solar thermal systems

A system is in a state of stagnation if the collector circuit pump is not in operation but the insolation continues to heat up the absorber. This state can be caused by a technical defect in the system, by a power outage, or simply by the lack of a consumer (the heat storage unit is already charged). The results of extensive analyses of stagnation behaviour are detailed below (Hausner et al., 2003).

7.1.5.1

Processes occurring during the stagnation state

When the collector circuit enters into a state of stagnation while insolation is sufficiently high, the temperature in the selectively coated collectors generally climbs above the boiling point (>120 - 150°C) of the highly pressurized heat transfer liquid in the collectors.



Figure 58: Solar thermal systems in multi-storey residential buildings are basically so dimensioned that no stagnation condition occurs during normal operation. However, a long period of warm weather (and thereby a charged energy storage tank), an electrical power outage or a technical defect could just as well cause this condition (picture source: AEE INTEC).

In principle, the stagnation of the system involves the following processes and phases:

Phase 1 — Expansion of the liquid

After the liquid has expanded somewhat due to the rise in temperature, it begins to evaporate.

Phase 2 — Ejection of the liquid from the collector due to initial vapour generation

The initially generated vapour pushes most of the hot liquid content of the collector into the system. Additional liquid thus makes its way into the expansion tank, leading to a substantial increase in system pressure.

Phase 3 — The collector boils dry — saturated vapour phase

If the collector has become permeable to vapour in this way, any liquid remaining in the collector is no longer ejected, but evaporates instead (saturated vapour). Depending on the energy it transports, this vapour can intrude into the system to a greater or lesser degree, where it will push the other liquid into the expansion tank. This increases the system pressure further, and it now reaches its maximum value. In all of the areas of the system reached by the vapour, temperatures now rise to levels that correspond to the saturated vapour temperature at the respective pressure (approx. 130 – 150°C). In the worst case, the vapour can in this way reach and damage temperature-sensitive system components.

Phase 4 — The collector boils dry — phase with saturated and superheated vapour

As the remaining fluid evaporates, the collector dries out further. Less vapour is produced, and the load on the system eases up again. The expansion tank once more forces liquid back into the system

and the pressure drops. While the vapour becomes superheated inside the collector, which is now dry, and the absorber reaches temperatures that could exceed 200°C, depending on the insolation, the saturated vapour temperatures outside the collector decrease somewhat. Finally, liquid again reaches the level of the lower collector connection. This state can then last for a few hours.

Phase 5 — Refilling the collector

Only when the levels of solar radiation, and thus the collector temperatures, have dropped sufficiently is the collector refilled with liquid.

It is apparent from this description of the process leading to the stagnation condition that the amount of residual liquid remaining in the collector at the end of Phase 2 plays a major role in determining its stagnation behaviour. Collectors or systems with good outflow behaviour have very small quantities of residual fluid and thus only small vapour ranges. In these systems, the stagnation process will run its course without problems, and the user may not even notice it. On the other hand, unsatisfactory outflow behaviour can lead to high vapour ranges and the overheating of system components.

The maximum specific vapour output in the event of stagnation is a dimension value that describes the outflow behaviour of collectors. It reaches its peak at the end of Phase 3, when the insolation is at a maximum (the latter can be as high as about 1200 W/m² for short periods). Whereas this output ranges from 20 to a maximum of 50 W per square metre of collector surface for flat plate collectors with good outflow behaviour, up to 120 W/m² has been measured in the case of poor outflow behaviour.

With this dimension value, it is possible to determine the advance of the vapour through the feed and return piping into the system from the thermal losses of these lines at saturated vapour temperature.

7.1.5.2

Influence of collector and system hydraulics on stagnation behaviour

The design of the internal collector interconnection has a major impact on the stagnation behaviour of solar thermal systems. Absorber interconnections (Figure 59) with good outflow behaviour have at least one (manifold) connection to the collector at the bottom (even when the interconnecting pipe attached to it is guided upwards again, as in Figure 59, top right). On the other hand, collectors in which both collecting tube connections are at the top have poor outflow behaviour (a great deal of residual fluid remains in the collector, and it evaporates slowly, which means a large vapour range — Phase 3).

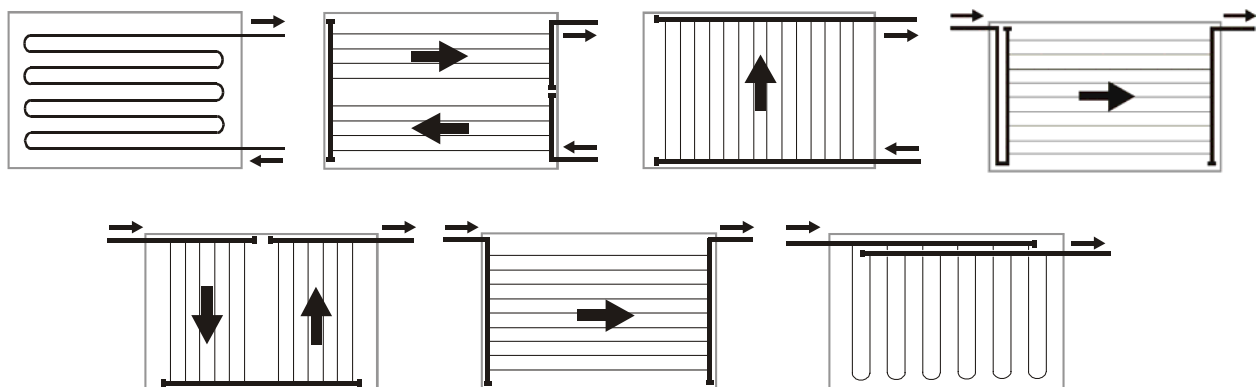

Figure 59: Evaluation of different outflow behaviour in the stagnation condition.

It should be borne in mind that if the system has an inappropriate design (poor system hydraulics), even a collector that empties well in principle can exhibit poor outflow behaviour. In addition to inappropriate piping (connection of the individual collectors or main connection lines), the positioning of the non-return valve relative to the membrane expansion tank can have a major impact on the stagnation behaviour (see Figure 60).

If the arrangement is inappropriate (see Figure 60, right), the collector cannot empty into the return piping, and only the feed line is available to release the vapour output. The key issue is the position of the connection to the expansion tank relative to the non-return valve.

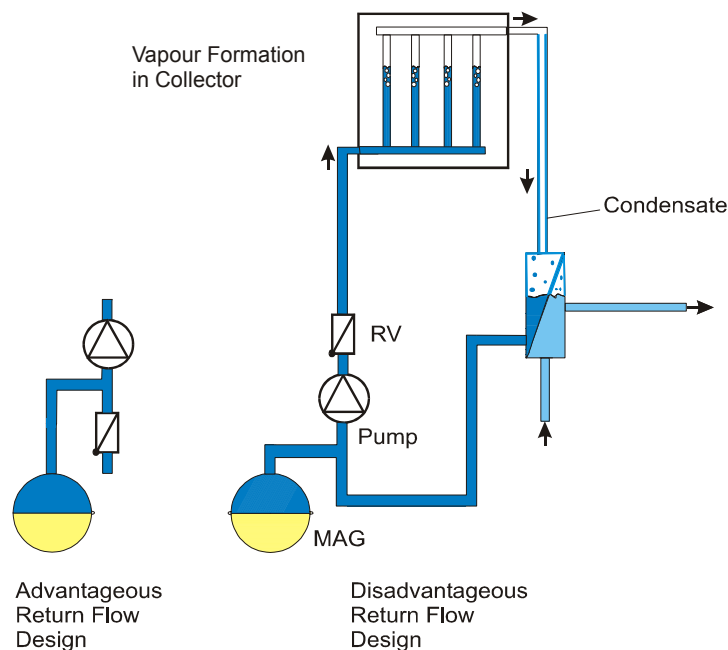

Figure 60: The stagnation behaviour depends on the return valve design.

7.1.5.3

Modified dimensioning of the membrane expansion tank

Methods previously used to calculate the volume of the membrane expansion tank often led to results that were too optimistic. The effects of a stagnation state were taken into account only partially or not at all. The following describes a calculation method in which the impact of stagnation is taken into account in accordance with the most up-to-date findings.

The nominal volume V_N of the expansion tank (equation 12) is calculated from the thermal expansion of the total heat transfer medium content $V_G \cdot n$, the liquid reserve V_v , the vapour volume V_D and the efficiency N . However, a much higher vapour volume must generally be assumed compared to the previous dimensioning. Corresponding to the information given previously, it is the volume of all of the pipes and components reached by the vapour.

In the new calculation method, the efficiency N (equation 14), which was previously calculated based on system pressure P_e and tank input pressure P_0 , now takes into account a potentially significant height difference H_{diff} between the expansion tank and the safety valve (can in practice be located on different storeys of a building, resulting in the pressure difference P_{diff}). On the other hand, the change in temperature in the gas filling between the pressure setting (e.g. low ambient temperature) and operation (increases of up to approx. 30 K have been measured) was taken into account (resulting in quotient 0.9). These changes are derived from the application of the general gas laws in connection with existing conditions.

 _VP_EQN_... [l] *Equation 12*

 _VP_EQ... [] *Equation 13*

 _VP_EQN_16.GIF [] *Equation 14*

 _VP_EQN_17.... [bar] *Equation 15*

V_N Nominal volume of the expansion tank [l]

V_G Total volume of the heat transfer medium [l]

V_v Liquid reserve [l]

V_b Maximum vapour volume [l]

n Expansion factor (≈ 0.09 for expansion up to $\approx 120^\circ\text{C}$ for 40% propylene glycol)

N Efficiency of the expansion tank, must be ≤ 0.5 in line with manufacturer's specifications

ρ Density of the heat transfer medium [kg/m^3]

P_e System pressure at the safety valve = release pressure of the safety valve – 20% [bar]

P_0 Tank input pressure [bar]. The factor 0.9 in the term $(P_0+1)/0.9$ represents temperature changes in the gas volume due to the hot liquid.

H_{diff} Height difference between the expansion tank and the safety valve. H_{diff} = assembly height of the expansion tank minus assembly height of the safety valve [m]

P_{diff} Pressure difference corresponding to H_{diff} [bar].

As mentioned above, one purpose of the tank capacity is to cool the hot liquid flowing from the collector in the event of a stagnation state to the maximum permissible temperature of 90°C in accordance with the manufacturer's specifications.

The minimum liquid reserve V_v required in the expansion tank can be dimensioned by means of a compound calculation (equation 16) with the following assumptions:

- Maximum permissible temperature in the expansion tank $T_{max} = 90^\circ\text{C}$,
- Mean temperature of the primary circuit = 90°C ,

- Initial temperature of the liquid reserve $T_v = 50^\circ\text{C}$ (in accordance with previous measurements),
- In the worst case, the entire collector volume V_k at a temperature of $T_k = 130^\circ\text{C}$ must be accommodated within the expansion tank.



[1] Equation 16

V_v Liquid reserve [l]

V_k Collector volume [l]

T_k Temperature of the collector content upon reaching the expansion tank [$^\circ\text{C}$]

T_{max} Maximum permissible temperature in the expansion tank [$^\circ\text{C}$]

From these assumptions, it follows that the liquid reserve should approximately correspond to the collector content.

7.1.5.4

Conclusions for the design of stagnation-proof systems in multi-storey residential buildings

Solar systems in multi-storey residential buildings are always designed to ensure that a stagnation state only rarely occurs during normal operation of the system. But such a state can nevertheless occur as a result of prolonged periods of good weather (resulting in a fully charged heat storage unit), of a power failure, or of a technical defect. The potential of a stagnation state must therefore be taken into account during the initial design phase of solar energy systems.

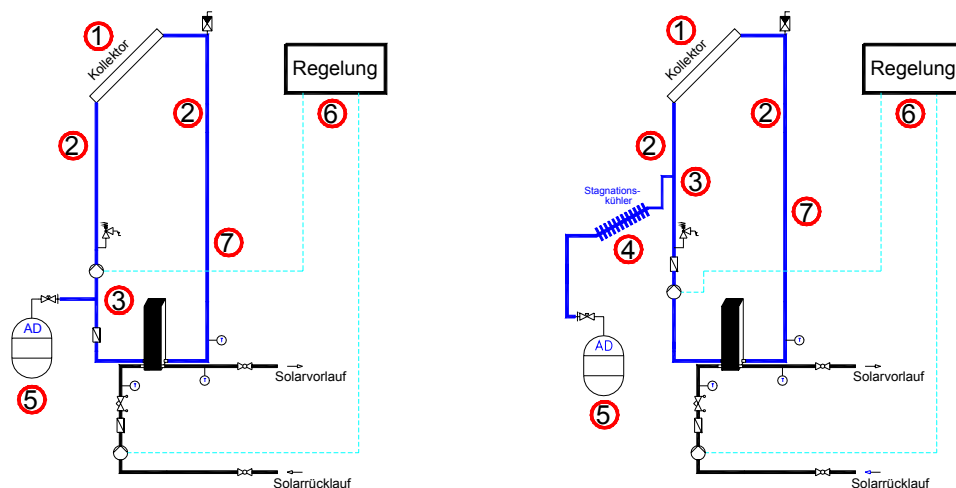

Figure 61: Things to consider with a stagnation-proof system design: Left: System without an automatic stagnation cooler (for collectors with properly emptying performance), right: system with an automatic stagnation cooler (for collectors with bad emptying performance).

(1) Use of properly emptying collectors, interconnections and systems.

- These elements provide specific vapour outputs of $<50 \text{ W/m}^2$, resulting in favourable vapour ranges.
- They also reduce the frequency of condensation.
- And they reduce the proportion of overheated residual fluid and prolong the service life of the heat transfer medium.

(2) Ensuring that pipework leads downward from the collectors and avoiding pockets of fluid.

- Prevents condensation within pipes.
- A potential for condensation remains at T-pieces that connect areas of collector fields, though such occurrences are much reduced in frequency.

(3) Component layout: non-return valve — connection to expansion tank — return piping:

- A prerequisite for a properly emptying system.
- Drastically reduces the vapour range.
- Reduces the overheated residual fluid component.

(4) Use of a stagnation cooler located at a geodetically higher position in the case of an unfavourable system configuration and high vapour ranges:

- Protects all temperature-sensitive components, especially the expansion tank, against excessively high temperatures (saturated vapour).
- Minimizes the volume of the expansion tank.
- Non-return valve can be installed using accepted practices

(5) Dimensioning of the expansion tank and safety valve (see Section 7.1.5.3):

- Safety valve: 6 bars release pressure
- Minimum system filling pressure: 2.5 bars (overpressure)
- Vessel standby pressure at least 0.5 bar below system filling pressure

This dimensioning provides the following properties:

- Protection of the expansion tank membrane against excessively high temperatures resulting from hot fluid from the collector without use of an intermediate vessel.
- Noticeable reduction in vapour range compared to low filling pressure.
- Adequate pump feed pressure

(6) Required controller functions:

- No pump operation at collector temperature $> 120^\circ\text{C}$ (prevents the system restarting in the stagnation state).
- Optional: rotary speed-regulated start-up of the secondary circulation pump when heat exchanger is exposed to saturated vapour.
- Optional: rotary speed-regulated start-up of both pumps for nocturnal cooling.

(7) Recommended heat transfer media:

- For systems with flat-plate collectors: type "Tyfocor L" (or comparable products) can be used at up to approx. 160°C (not as permanent operating temperature!)
- For systems with vacuum collectors: Ttpe "Tyfocor LS" (or comparable products) can be used at up to approx. 200°C (not as permanent operating temperature!)

The preceding information applies to fluid-phase heat transfer media and is limited to periods during which stagnation prevails (not a permanent operating state!)

7.2

Solar-supported heat supply system designs

Until a few years ago, heat distribution in solar-supported heat supply systems was usually accomplished by so-called four-pipe networks. By the mid to late 1990s, metrological analysis of many installed heat networks had demonstrated the limitations of solar-supported four-pipe networks in multi-storey residential construction. Unsatisfactory energy aspects (low degree of solar coverage and high heat losses of the overall system) combined with the necessary improvements in user satisfaction and convenience led to the definition of holistic solar-supported heat supply systems (Fink et al., 2000; Fernwärme Wien, 1998).

Heat supply systems based on the principle of two-pipe networks emerged as the preferred choice for general use with the redefined requirement profile. Initial pilot projects by property developers in Salzburg (a measure supported most enthusiastically by the building company, GSWB) not only proved successful with respect to user satisfaction, but also far exceeded all energy-related expectations. As a result of this favourable practical experience in implementation and of extensive theoretical work (Fink et al., 2002), two-pipe systems in conjunction with solar systems have become widely accepted as standard designs for heat supply in several Austrian federal states.

7.2.1

Solar-supported heat supply system designs based on the principle of 2-pipe networks

In two-pipe networks, heat supply to the residential units, including both domestic hot water and room heating, is by means of a pair of pipes. Domestic hot water is heated in a decentralised manner in the individual residential units using continuous flow water heaters, or by means of small drinking water reservoirs using the charge-store principle. While the trend in terraced house construction (low energy densities) favours the installation of smaller storage tanks in the residential units, so-called individual apartment units are preferred in compact multi-storey residential buildings (high energy densities) in which hot water for domestic use is heated by continuous water heaters.

7.2.1.1

Integrating the heat generators

As discussed in 7.1.3.1, solar systems in multi-storey residential buildings are generally designed according to the low-flow principle. To provide the consumer with high-temperature energy as directly as possible and without admixture, the heat storage unit must be charged with heat at the appropriate temperature. Extensive mathematical simulations as well as actual measurements have shown that, based on typical consumption profiles in multi-storey residential buildings and the prevailing low degree of solar coverage, the effect of special stratified charging strategies on the degree of solar coverage in large solar systems is small (Fink et al., 2002). Systems that are based on simple and low-cost charging strategies (consisting of rotary speed control and corresponding store management) have become widely accepted for this application.

Two widely used charging strategies are illustrated as examples in Figure 62 and Figure 63. A key factor in both concepts is the appropriate function of the rotary speed control and correct positioning of the height of the pipe connections in relation to the pipe connections of the conventional heat generator.

If the solar input is provided at only a single level, it must always be below the standby volume, which is kept at a constant temperature by the conventional heat generator (Figure 63). If two input levels are provided (Figure 62), connecting the feed-in pipes at the very top of the storage tank or at two-thirds of its height (from the bottom) has proven successful. The switchover between these two inflow levels is temperature-regulated by means of a three-way switchover valve.

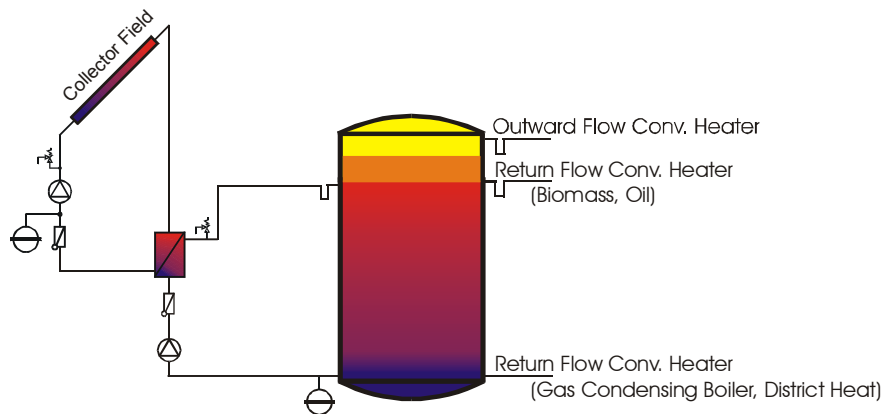

Figure 62: Temperature oriented charging in two levels of the storage tank.

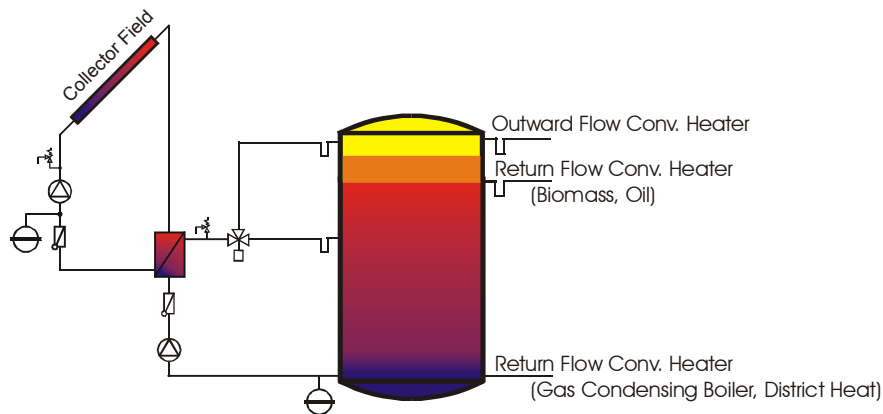

Figure 63: Charging of the storage tank at one level – just below the standby volume.

It should also be noted that the connection height of the return flow to the conventional heat generator depends on the type of heat generator. While the connection of the return flow in the case of biomass or oil boilers should be directly under the standby volume, higher annual degrees of system utilisation can be achieved with return flow connections in the lower third of the store volume in the case of heat generators using district heating and gas-fuelled condensing boilers. In such contexts especially, a holistic view of the system is essential.

7.2.1.2

Solar-supported heat supply systems — two-pipe networks combined with decentralised apartment units

Figure 65 shows the block diagram of a solar-supported heat supply system featuring heat distribution via a two-pipe network and heat output via so-called decentralised apartment units. The heat storage unit is the central point for all the heat flows and also acts as a hydraulic switch. Both the solar-powered system and the conventional heat supply system are connected according to the description in Section 7.2.1.1. In order to guarantee a reliable supply of heat with this design, it is essential that adequate reserves are permanently stored in the upper region of the heat store so as to cover peak demand. Details on how to ensure the reliability of supply are given in Section 8.2.



Figure 64: The heat storage tank acts like a hydraulic switch between the heat supplier and consumer. The properly arranged connections and sensor devices to the storage tank have to be fixed in detail at the planning state (picture source: AEE INTEC).

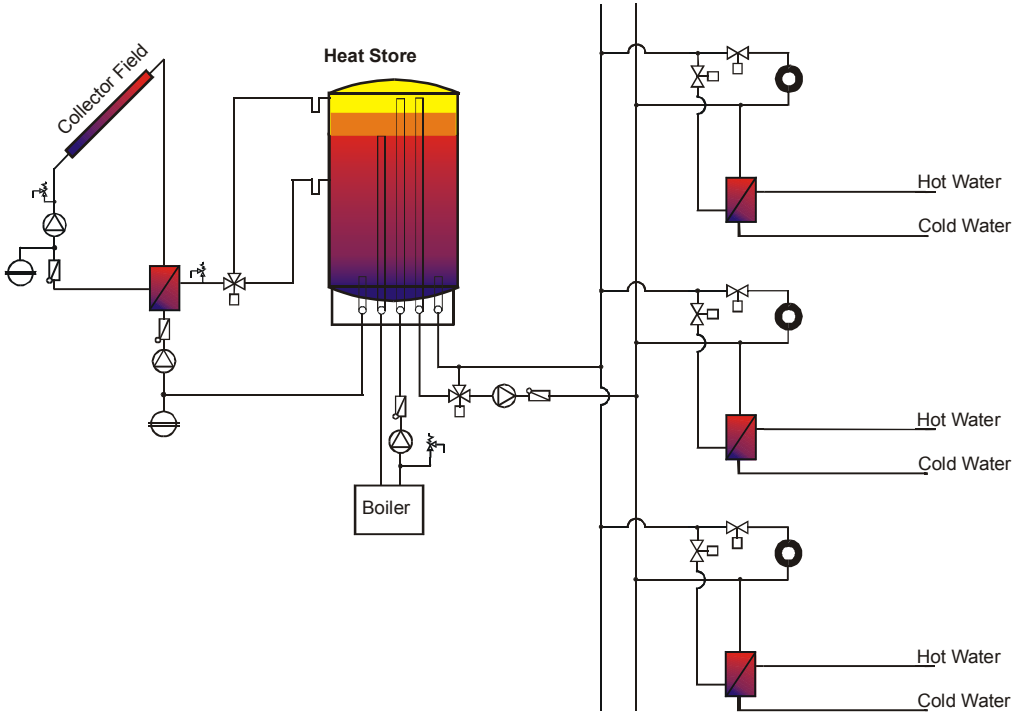

Figure 65: Solar-supported heat supply concepts: two-pipe network connected to the decentralised apartment unit.

A network pump and an admixer unit are used to supply the components of the residential unit transfer station via a two-pipe network at a constant year-round supply temperature of 65°C. Whether

the return temperatures required for efficient operation of the solar system (in practice, an average return temperature of 30°C is necessary) can be attained is now dependent on the size, equipment and regulation of the components. Due to the low return temperature, the only pipe now suffering losses is the feed pipe.



Figure 66: Solar-supported heat supply through a two-pipe network with apartment units in the housing estate "Stieglgründe" in Salzburg, Austria (picture source: Sonnenkraft, Carinthia, Austria)

Application

Two-pipe networks in combination with decentralised apartment units are ideally suited for use in new-build terrace houses and compact residential unit blocks. For less compact types of building (lower kWh heat requirements per metre of heat distribution pipe), a two-pipe network in combination with decentralised daily storage is preferable.

Solar-supported heating networks in combination with decentralised apartment units are also highly suitable for use in existing buildings. This includes multi-storey buildings which are equipped with central space heating but also have a decentralised supply of domestic hot water (off-peak energy storage units). Whenever these energy storage units have to be renewed, they could then be replaced by decentralised apartment heat transfer units. At the same time, improvements to the heat insulation (insulation of the building envelope, new windows) will mean that the radiators can be operated at lower temperatures.

Similarly, the system is also ideal for converting gas-fired residential unit heating systems to a centralised, solar-supported heat supply system. In this case, the existing gas supply line can be adapted for use as the return pipe of a two-pipe network. In other words, only the feed pipe now needs to be installed for the connection to the decentralised apartment unit.

7.2.1.2.1

Apartment heat transfer units

The idea of the apartment units originated in Scandinavia and they are already equipped with practically all the components required to ensure an efficient and unproblematic operation of the domestic heat supply. Moreover, they are not only compact and industrially manufactured to the

highest quality but also feature components that do not require an external supply of power. Although decentralised apartment units were originally used in the field of district heating, there are now four or five suppliers in Austria who supply units specially developed for use in multi-storey residential buildings (cf. the products of two suppliers are shown in Figures 67 and 68).



Figure 67: Apartment unit from the company Redan (picture source: AEE INTEC)



Figure 68: Apartment unit from the company Logotherm (picture source: Logotherm, Germany).

The rapidly increasing volume of sales in this sector along with the technological advances of recent years have generated heightened competition between rival suppliers, which in turn has brought about a significant fall in the capital costs required to install apartment units. At present, the cost of an apartment unit with standard equipment is only slightly above that of conventional off-peak energy storage units.

At the same time, the rise in demand has meant that there are now units specifically designed for use in multi-storey residential buildings. For example, there are now units available that are slim enough to be installed in bathrooms (see Figure 69) and utility rooms. In practice, the most common place of installation is above the toilet cistern. The crucial point is to minimise the distance between the unit and the tap and/or service shafts. One company already offers concealed installation of apartment units to depths of 100 to 150 millimetres, depending on the layout (Figure 70).



Figure 69: An on-wall apartment unit, product from Redan (picture source: AEE INTEC).



Figure 70: A concealed apartment unit, product from Redan (picture source: AEE INTEC).

Properly equipped apartment units contain all the components required to provide decentralised heating of domestic hot water, to provide a hydraulic equalisation of the space heating, and for long-

term operation and maintenance. Figure 71 shows a block diagram of the two-dimensional functional layout of the components.

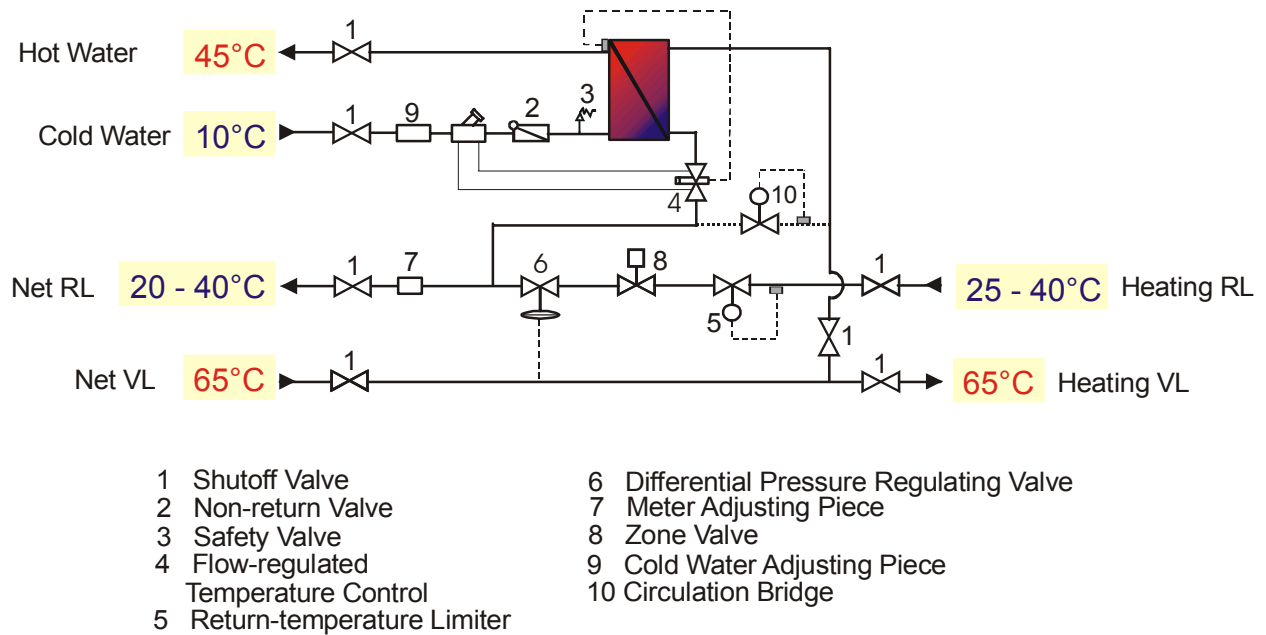

Figure 71: Block diagram of the functional layout of the components in an apartment unit and allocation of the typical operating temperatures.

Heating Domestic Water

The domestic water is heated by means of a constant flow water heater equipped with a plate heat exchanger. Given that the domestic water is heated directly, as and when required, there are no water hygiene problems. Provided that the pipe to the tap is kept as short as possible, there is practically no chance of any growth of legionella.

At the same time, a restriction of the temperature of the domestic water prevents any limescale on the plate heat exchanger. This is regulated by a so-called proportional controller, which adjusts the volume flowing through the network to the volume currently flowing from the tap and thereby regulates the temperature of the domestic hot water. Most proportional controllers allow the set point temperature of the domestic hot water to be adjusted.

Another important component for the heating of domestic hot water is the so-called circulation bridge, which should be an essential feature of any apartment unit. This not only increases convenience, but also limits the return temperature. In the absence of a circulation bridge, the network feed pipe would slowly cool down in summer operation mode whenever the water was not being drawn. As a result, it would take longer to reach the set point temperature whenever hot water was drawn from the system. The circulation bridge permits a minimal flow (heat exchanger bypass), which keeps the network feed pipe at the required temperature, thereby ensuring a rapid supply of hot water. In order to prevent the return temperature from rising, a return temperature limiter must be fitted in the bypass pipe. If the set point of the limiter can be adjusted, care must be taken to ensure that an appropriate temperature is selected (35 to 40°C is standard) and that a seal is also affixed to the limiter. The principal components for heating the domestic hot water are represented schematically in Figure 72.

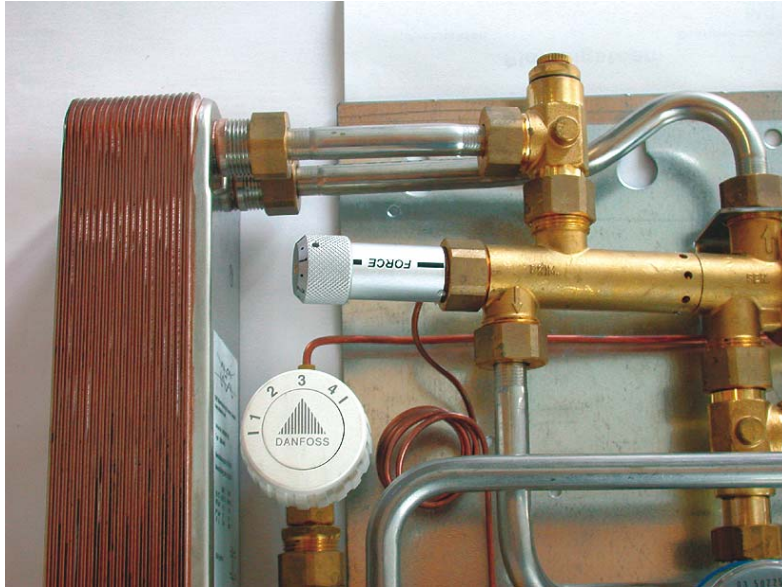

Figure 72: Components for heating the domestic hot water – plate heat exchanger, adjustable proportional controller and circulation bridge with return temperature limiter (example from the product from the Redan company) (picture source: AEE INTEC).

Hydraulics of the space heating supply system

Differential pressure valves are essential for the hydraulic equalisation in the residential units. These control fittings are standard in the space heating supply circuit of apartment heat transfer units. In order to prevent improper adjustment, it is recommended that fixed preset differential pressure regulating valves be used. A standard value here is a differential pressure of approx. 0.1 bar.

Alongside the use of a differential pressure regulating valve, it is also advisable to fit a return temperature limiter in the space heating supply circuit. Although this is normally unnecessary when a differential pressure regulating valve has been fitted along with properly adjusted kvs-inserts on all radiator valves, use of this extra "safety valve" has become standard practice (also on account of the low cost involved). The differential pressure regulating valve and the return temperature limiter are represented schematically in Figure 73.



Figure 73: Differential pressure regulating valve (right) and return temperature (left) limiter from the apartment unit (example the product from the Redan company) (picture source: AEE INTEC).

The hydraulic equalisation of the space heating supply in the apartments also includes the use of radiators fitted with preset kvs-inserts. The radiators are generally designed to operate at temperatures from 65/40 in two-pipe networks. The occupant determines the actual room temperature by adjusting the thermostat (Figure 74). If required, a zone valve may also be installed in the hydraulics of the apartment unit. In combination with a room sensor and a time-control device, this can then be used to lower the temperature at night. However, experience shows that this is not usually required and that room temperature can be conveniently controlled via thermostat.



Figure 74: The room temperature is adjusted via a thermostat (picture source: AEE INTEC).

Heat meter and water meter

In two-pipe networks, the amount of heat consumed is measured by means of an electronic heat meter. By law, heat meters have to be calibrated every five years, and their acceptance compared to evaporimeters is therefore high — also among occupants. The heat meters can be either read directly or from some central point within the building by means of an M-bus-protocol, which saves having to gain access to each dwelling. In addition to a heat meter, a cold-water meter can also be installed to measure the use of domestic water. Depending on the choice of product, such meters can also be read remotely via an M-bus. The arrangement of heat meter and cold-water meter is represented schematically in Figure 75.



Figure 75: Arrangements of an electric heat meter and a cold water meter (example from the company Redan) (picture source: AEE INTEC).



Figure 76: The central arrangement for the shut-off valve enables a quick act in case of emergency or for maintenance (example from the company Redan) (picture source: AEE INTEC).

7.2.1.2.2

The heat distribution network

A specific characteristic of a two-pipe network in combination with apartment units is that the volume flowing through the network fluctuates considerably according to the domestic hot water usage and

heating requirements. The maximum volume flows through the heat distribution network in winter (both domestic hot water and space heating), and the minimum in the summer months (only domestic hot water). The difference can be considerable so that in order to save electricity, it is therefore recommended that a variable-speed heavy-load pump be installed for use in the winter (main heating season) and a variable-speed light-load pump for use in the summer (see Figure 78). The switchover from one pump to another in spring and autumn can be conducted either via a teleservice system, if the requisite equipment is in place, or on the spot by the heating operator.



Figure 77: Riser strings adjusted through the differential pressure regulation. Detail: Riser strings can easily be bled through a maintenance friendly positioning in the basement.



Figure 78: Parallel arrangement of the pumps for the winter use (left) and summer use (right) including an admixer unit (picture source: AEE INTEC).

In order to create an optimal heat distribution network for multi-storey residential buildings, it is also necessary to ensure that the riser strings are properly hydraulically regulated. As mentioned above, the volume flow also fluctuates greatly in individual riser strings. As a result, differential pressure regulating valves must be installed rather than simple string control valves.

As a rule, the network is operated at a constant feed temperature all year round. Experience has shown that set point temperatures of between 60 and 65°C are suitable here. This involves the use of standard admixer units, which are subjected not only to the greatly fluctuating volume flow but also to different temperatures from the heat storage unit. This problem can be reduced by ensuring that the

temperature at which the heat storage unit is charged by the conventional heat generator remains close to the set point feed temperature of the distribution network. It is absolutely essential to take this into account when planning and implementing the integration of the conventional heat generator. If the two temperatures can be kept close together, the load on the admixer unit remains very low the whole year round, since the buffer temperature corresponds more or less to the network feed temperature.

It is only during the summer months, when the daily solar energy yield is greater than daily consumption, when heat storage temperatures of up to 95°C may occur. In such cases (a margin of fluctuation of $\pm 5^\circ\text{C}$ in the feed temperature is acceptable), electronic admixer units with suitable control strategies can be used (Meisl, 2003). Thermal fixed-value regulators that do not require any external source of power can also be used. Figure 79 shows a thermal admixer unit which does not require a separate supply of power as installed for a residential building comprising 42 dwellings. Figure 80 shows the network temperatures recorded over a week in summer as an example. The values show that at heat storage temperatures of up to 85°C, the feed temperature in the network fluctuates by a maximum of $\pm 2.5^\circ\text{C}$. The use of thermal fixed-value regulators is highly recommended here, not least on account of the low capital costs involved.



Figure 79: Admixer unit with fixed temperature adjustment without auxiliary energy (picture source: AEE INTEC).

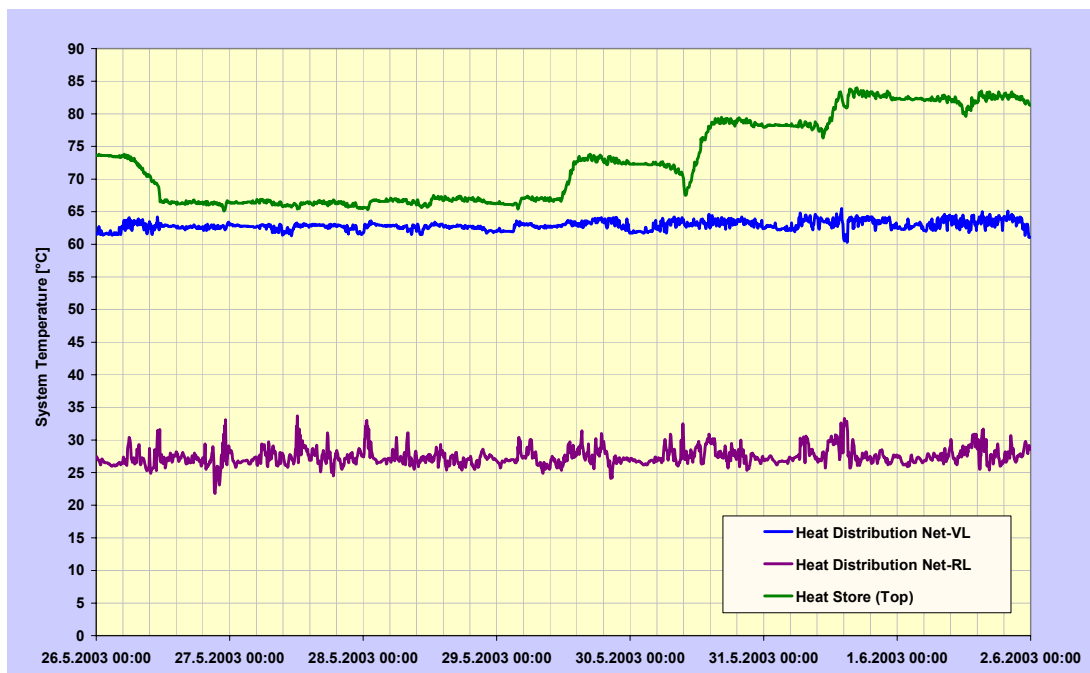

Figure 80: The satisfying mixer function of thermal tank at high storage temperatures can clearly be recognised (end of May/beginning of June). The supply temperatures are constant and just below 65°C, the return temperatures lie between 23 and 33°C.

If the feed temperature in the network were to fluctuate considerably, this would also have a rather damping effect on the network return temperature. That this is not so in the present example is demonstrated by the consistency of the return temperatures at values between 23 and 33°C.

As the values for a summer week in Figure 80 show, the return temperatures in a two-pipe network with apartment heat transfer units and a properly hydraulically equalised heat distribution network are around 30°C throughout the year, which constitutes optimal operating conditions for an efficient solar system.

7.2.1.3

Solar-supported heat supply systems — two-pipe networks combined with decentralised domestic hot water storage units

Figure 81 shows the block diagram of a solar-supported heat supply system featuring heat distribution via a two-pipe network plus decentralised heating of the domestic hot water in daily storage tanks. As with the two-pipe network for apartment heat transfer units, the heat storage unit is the central point for all heat flows and acts as a hydraulic switch. The integration of both the solar energy system and the conventional heat generator is as described in Section 7.2.1.1. With this type of two-pipe network, the dwelling is supplied with space heating for 22 to 23 hours a day. During the remaining one to two hours (charging period), the domestic hot water tank is recharged.

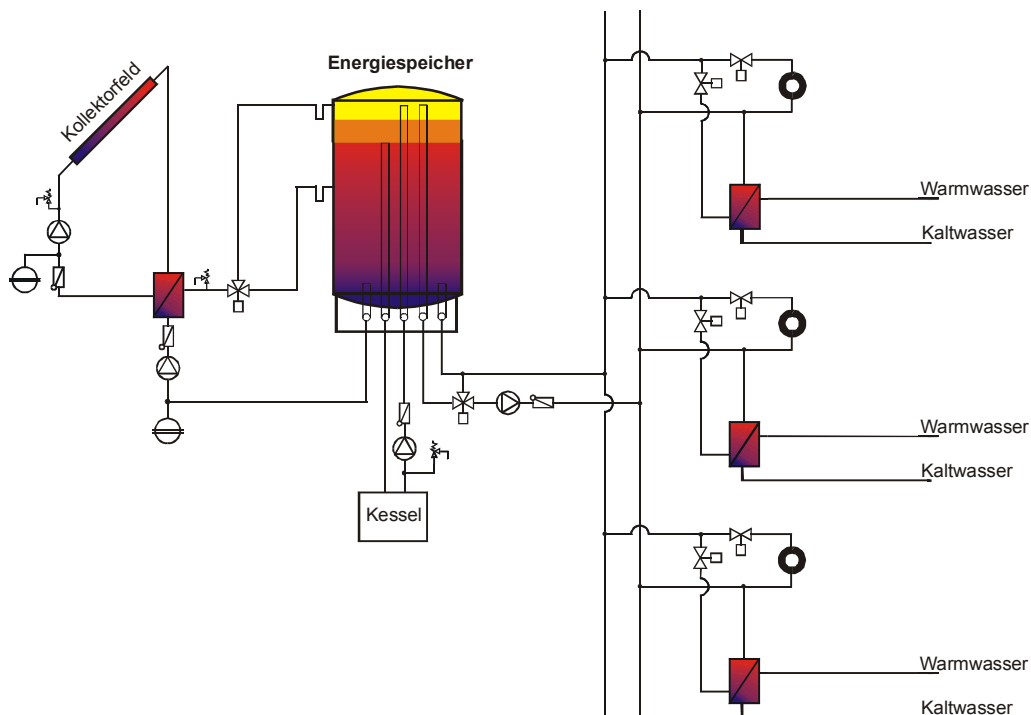

Figure 81: Solar-supported concept for heat distribution: two-pipe networks connected with the decentralised domestic hot water storage tank.

Here, it is important to ensure that at the beginning of the charging period there are enough reserves on hand in the heat storage unit, as a large proportion of the daily requirements for the heating of domestic hot water has to be met in a relatively short time. More precise details on how to ensure the reliability of supply are given in Section 8.2. The individual dwellings are supplied via a two-pipe network using a network pump and admixer unit. As with the design featuring decentralised apartment units, whether the low return temperatures required for efficient operation of the solar

system can be attained once again depends on the size, equipment and regulation of the apartment components.

Heating the Domestic Hot Water

The size of the decentralised domestic hot water tanks should be tailored to daily requirements. In practice, this means a volume of between 150 and 200 litres. As with off-peak energy storage units, these can be installed in utility rooms, bathrooms or toilets. If the building concerned has a basement, fixed domestic hot water tanks may also be accommodated there. Once again, however, the key criterion when selecting a location for the tank (with regard to convenience, reducing heat losses and minimising the risk of legionella) is to site it as close as possible to the tap. The domestic hot water tank should be charged via external heat exchangers in line with the charge-store principle. In practice, it is only with the use of external heat exchangers in combination with appropriately regulated charging mass flow rates that the requisite low return temperatures can really be attained. Care should be taken to ensure that charging and discharging are adequately hydraulically decoupled from one another. In practice, this means installing a sufficient number of storage connections.



Figure 82: Solar-supported heat supply system with a decentralised domestic hot water storage tank combined with a two-pipe network (picture source: AEE INTEC).



Figure 83: A decentralised domestic hot water storage tank with a two-pipe network. Neither volume nor the arrangement differs from a conventional off-peak energy storage unit (picture source: AEE INTEC).

If possible, the charging period chosen for heating the domestic hot water should coincide with the times at which room heating requirements are low. It is possible to increase the degree of solar coverage by, for example, selecting a charging period before the sun reaches maximum insolation (midday). In this case, the solar energy system benefits from a low temperature level in the lowest part of the heat storage unit at the most favourable charging time.

Space heating supply

As with two-pipe networks in combination with apartment units, the radiators should be planned to operate at temperatures of 65/40. Given that domestic hot water is heated at a time when the space heating supply is not in operation, the feed temperature for the space heating supply may, if desired, be controlled on the basis of the outdoor temperature. This set-up could also be used to run a low-temperature heat supply system, thereby further reducing heat losses from the distribution network.

With this design, too, the use of control valves in the dwellings (differential pressure regulating valves, return temperature limiters, preset kvs-inserts in the radiators in combination with thermostats) is once again absolutely essential.

Application

The major advantage compared to two-pipe networks with apartment units is that, for example, during the whole of the period when the heating is not in operation, the heat-distribution network only has to be at its operating temperature when required to charge the domestic hot water tank. As a result, heat losses from the distribution network are substantially reduced. However, given the higher capital costs of this design, on account of the need for decentralised domestic hot water tanks, its main field of application is in terraced or similar housing developments with low energy densities (low kWh heat requirements per metre of heat distribution pipe).

At the same time, this design also offers potential for the renovation of existing buildings. If the buildings are already equipped with localised domestic hot water tanks that can be modified and are in a reasonable condition (as a rule, off-peak energy storage units), these can be connected hydraulically to the existing central space heating supply system (two-pipe network).

7.2.1.4

Advantages and disadvantages of solar-supported two-pipe heat networks

Two-pipe networks designed according to the specifications described in Sections 7.2.1.2 and 7.2.1.3 possess numerous advantages over conventional heat supply systems. Not only do they use renewable energy, but they also make efficient use of resources and offer a high degree of user satisfaction and user convenience:

- As the heat is distributed via two pipes, heat losses can be substantially reduced. It must be ensured that the average temperature throughout the whole string of return pipes remains around 30°C so that virtually no heat losses are sustained in this area. In two-pipe networks, there is therefore only one heat distribution pipe that is subject to heat losses. As a result, the efficiency of this set-up is considerably higher than

that of a four-pipe network. In practice, this means lower supplementary heating requirements.

- The constant year-round return temperature of approx. 30°C is ideal for the efficient operation of solar energy systems. Numerous tests show that there is a greater solar energy yield with two-pipe networks as well as higher savings on energy for supplementary heating.
- The design of the two-pipe network is such that solar energy is also automatically supplied for space heating purposes. Experience shows that this boosts the solar energy yield by as much as 10 percent for the same system dimensioning.
- Extensive economic efficiency calculations for the full range of solar-supported heat supply systems (on the basis of the VDI Guideline 2067 from 1999) show that heat prices for two-pipe networks with apartment units are lower than those for four-pipe networks (Fink et al., 2002). The range of buildings compared in this study numbered between five and 48 dwellings. However, when combined with decentralised domestic hot water tanks, two-pipe networks only have a commercial advantage over four-pipe networks in terraced or similar housing developments with low energy densities. This is because of the higher costs for the decentralised hot water tanks.
- Given that the network feed temperature is constant throughout the year, the room temperature can be adjusted to the occupant's needs to a far greater degree than is possible with, for example, four-pipe networks.
- Instead of being switched off sometime in May and switched on again in September, the space heating supply is in operation throughout the summer. This means that the needs of individual users for extra heat can also be met in the summer months.
- With two-pipe networks, the feed temperature in the network also remains the same during the night, which means substantially increased comfort for all people who don't keep regular hours.
- With two-pipe networks, the cost of domestic hot water and space heating are calculated using electronic heat meters. As these must be regularly calibrated, they enjoy a much higher acceptance among occupants than the evaporimeters generally used with four-pipe networks.
- The installation of electronic heat meters has resulted in a much greater motivation for the occupants to save energy.
- If required, and in contrast to off-peak energy storage units, almost unlimited quantities of domestic hot water can be drawn from the system.
- Heating domestic hot water on a decentralised basis (using continuous flow water heaters or in small daily storage units) means absolutely scrupulous water hygiene as well as protection against limescale and scalding.
- Apartment heat transfer units are industrially manufactured to the highest quality standards. The advanced level of prefabrication reduces the potential for errors on the building site and thus improves the quality of installation. Despite their standardisation, the apartment units can be equipped according to the specifications of the residential developer or the engineer responsible for the building services.
- Affixing seals to the control valves in the apartment units effectively prevents manipulation by occupants.
- No auxiliary energy supply is required to heat either the domestic hot water or operate the control elements in the apartment units.



Figure 84: Solar-supported heat supply system for the housing estate "Hans-Riehlgasse", erected on the existing building. The solar thermal system was connected to a four-pipe network, since this was already at hand (picture source: S.O.L.I.D.).

7.2.2

Solar-supported heat systems with four-pipe networks

For solar-supported heat supply systems in new-build multi-storey residential buildings, four-pipe networks are inferior to two-pipe networks. Nevertheless, there are some cases (e.g. renovation projects involving the use of an existing central domestic hot water system) where it makes sense to use the existing heat distribution pipes. For this reason, the following section will concentrate on solar-supported heat supply systems with four-pipe networks and their use in the renovation of existing buildings.

Four-pipe networks are used for systems which provide both domestic hot water and space heating on a central basis. The heat is distributed via four pipes. In addition to flow and return pipes for the space heating system, four-pipe networks also have two pipes with drinking water for the supply of domestic hot water (distribution pipe for domestic hot water and circulation line).

7.2.2.1

Solar-supported heat supply systems using four-pipe networks combined with single tank storage systems

If an existing four-pipe network in a small residential building (with up to approx. 10 dwellings) is to be upgraded by the addition of solar-supported heating of the domestic hot water, the use of a simple

single tank system is to be recommended. Depending on the state of the existing domestic hot water system, it may be possible to reuse components. If this is not the case, the tank system must be newly installed. In this kind of design, domestic hot water tanks (Figure 85) or uncoated steel tank-in-tanks can be used as heat stores to heat domestic hot water (see Figure 86).

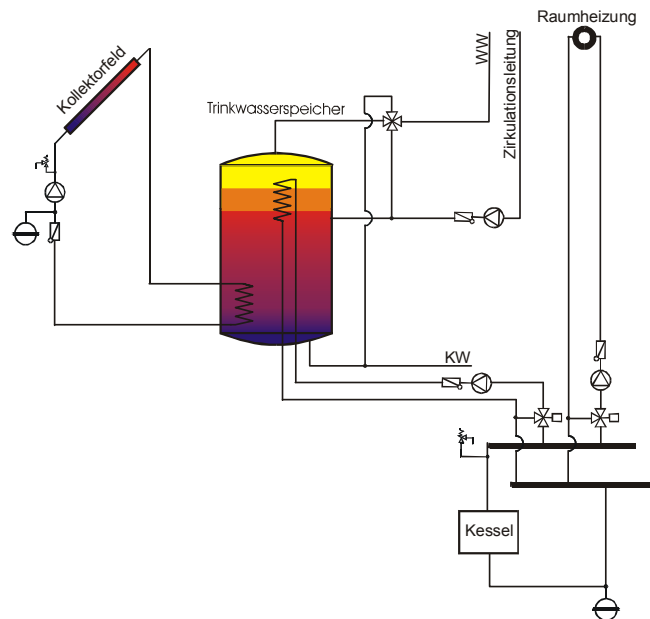

Figure 85: Solar-supported heating of domestic hot water for a maximum of 10 apartments using single tank storage systems. The hot water is stored in a domestic hot water storage tank.

Systems with domestic hot water tanks (Figure 85)

Domestic hot water tanks have an inner coating or are made of stainless steel. As such, they are generally much more expensive than conventional uncoated steel tanks. This significantly increases the cost of installing the solar energy system in larger systems. Experience shows that a sensible limit for the size of such systems is around 10 dwellings.

If plate heat exchangers are used for the solar or supplementary heating heat exchangers, this can result in limescale at temperatures above 60°C, leading to lower yields due to the reduction in flow or even a complete blockage of the heat exchanger. Technical problems of this kind lead to ever increasing maintenance and renewal costs, which in turn substantially diminish the profitability of the system. The little experience that there is with decalcification systems at high temperatures has yielded widely varying results. At the same time, large drinking water tanks require special precautions regarding water hygiene (cf. Section 7.1.1).

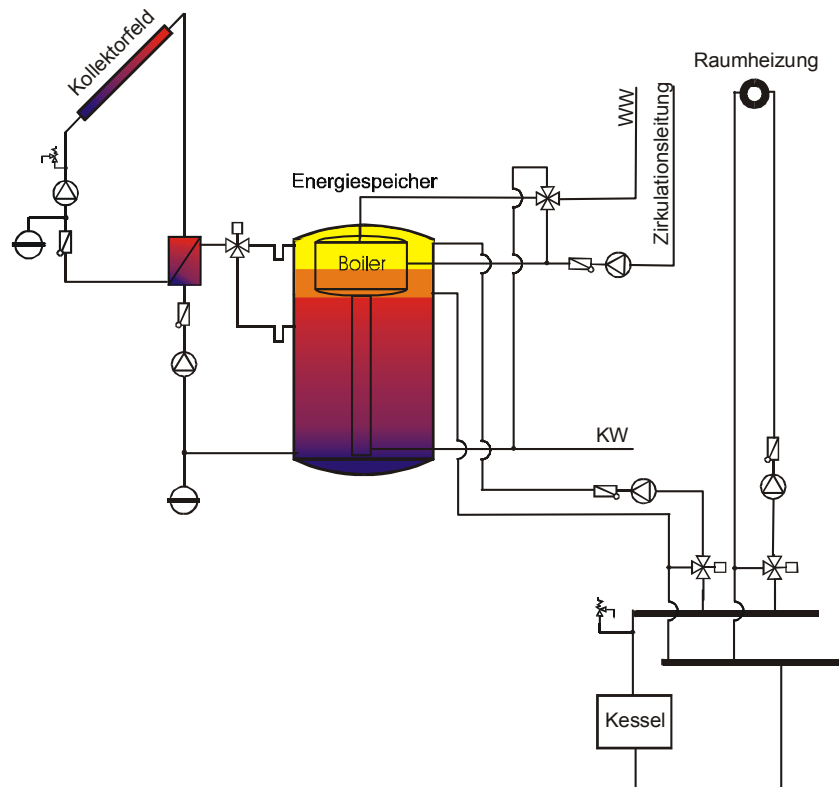

Figure 86: Solar-supported heating of domestic hot water for a maximum of 10 apartments using single tank storage systems. The hot water is stored in a conventional uncoated steel tank connected with an integrated domestic hot water tank.

Systems with a conventional steel tank and integrated domestic hot water tank (Figure 86)

This design envisages an integrated domestic hot water tank or an integrated pipe bundle for system separation. The heat transmission takes place between a standing energy storage medium and the drinking water contained in the integrated domestic hot water tank. As very poor heat transmission is a property of this design, it is important to select a domestic hot water tank with an appropriate ratio between volume and surface area to ensure coverage of peak requirements. There are two ways of ensuring that peak demand for hot water can be met: storage of a sufficient quantity of domestic hot water, which necessitates the use of an extremely large volume; or use of a tank with a sufficiently large surface area so that as much water as possible can be heated instantaneously. If a "preheating pipe" is used to extend the integrated domestic hot water tank into the lower part of the heat store, good cooling of the water in the heat store can be achieved. The solar energy system can be integrated via an external or internal heat exchanger, depending on the collector area.

7.2.2.2

Solar-supported heat systems: four-pipe networks combined with two-tank systems

Use of a two-tank system is recommended when installing a solar-supported heat system for domestic hot water or even to support the space heating supply in larger residential complexes (more than 10 dwellings) that are already equipped with a four-pipe network. Two-tank systems consist of a simple, uncoated steel tank, which serves as a heat store, and a small domestic hot water tank to cover peak loads. Depending on the requirements for domestic hot water, the standby tank is instantaneously charged by an external heat exchanger. As in Section 7.2.2.1, the existing domestic hot water tank can be reused as a standby tank, provided that it is in good condition.

Figure 87 shows a two-tank system for solar-supported heating of domestic hot water. Experience shows that solar energy systems which also serve the space heating supply with respect to the hydraulics can provide up to 10 percent greater solar yields for the same dimensioning. This is because of a better exploitation of the solar energy system during the transitional period, when insolation is high. The costs of hydraulically implementing the space heating supply system are minimal. It is therefore recommended that this be planned as standard (Figure 88 and 89).

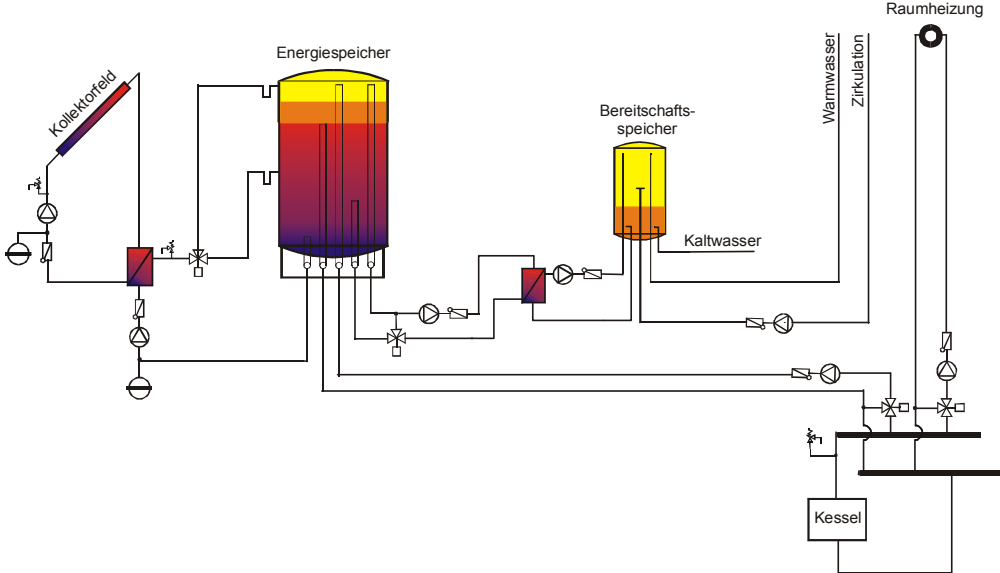

Figure 87: Concept for a two-tank system for solar-supported heating of domestic hot water for more than 10 apartments.

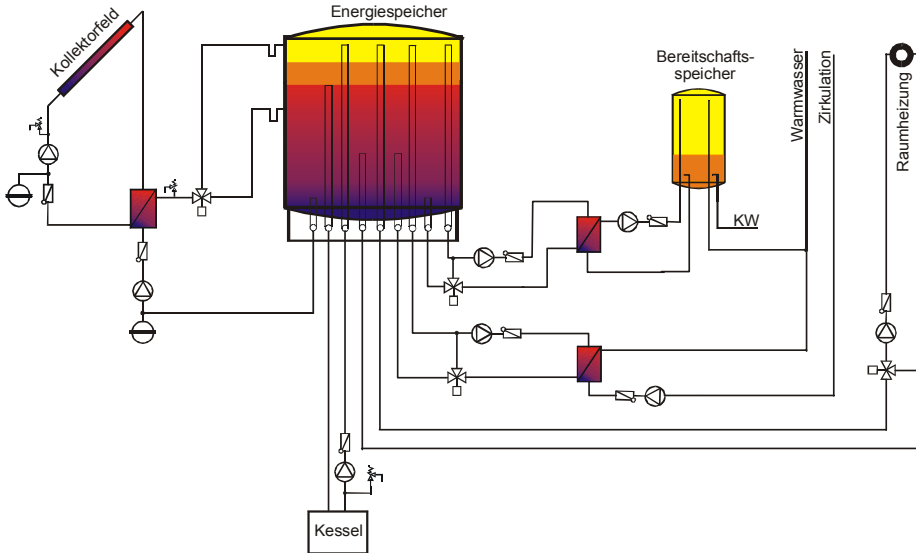

Figure 88: Concept for a two-tank system for solar-supported heating of domestic hot water and space heating for more than 10 apartments. Further is the return water reheated through an internal heat exchanger over the circulation line.



Figure 89: Two-tank system for solar-supported heating of domestic hot water and space heating based on a fore-pipe heat distribution network.

Hot water distribution networks with a circulation line are operated at a high temperature (60 / 55°C), which results in considerable losses. In other words, they represent a heavy “consumer” for the solar energy system. If the circulation line return is permanently connected to the standby section of the drinking water tank, the cold water flowing into the tank is mixed with the mass flow from the circulation line. In order to diminish this effect, an additional external heat exchanger can be inserted in order to heat the mass flow from the circulation line (see Figure 88).

8

Dimensioning

Great significance is given to the dimensioning of individual components in solar-supported heat supply systems. Above all the holistic approach, in particular the interaction between sections of the systems is to be taken into consideration.

This Section does not aim to give design guidelines for all of the components in conventional heating technology. Rather specific empirical values and dimensioning tools for system sections will be made available, which were in the past, according to our experience, the subject of frequent errors. On the one hand, this is true of the dimensioning of solar thermal systems and, on the other hand, of questions pertaining to the security of supply.

8.1

Dimensioning of solar thermal systems

In this Section recommendations are given for the dimensioning of important system components (collector area and solar storage tank volume) in two-pipe networks. In this respect, it is not only

energy aspects which are taken into consideration but also economic factors. It should be borne in mind that these are recommendations which simplify any in-depth preliminary design but cannot replace detailed planning of the components. In the detailed planning phase use can be made of suitable simulation programs such as TSOL (TSOL, 2003), Polysun (Polysun, 2003) or TRNSYS (Klein et al., 2000).



Figure 90: The dimensioning of solar-supported heat distribution networks has to be considered with a holistic approach.

8.1.1

Collector area and solar storage tank volume combined with two-pipe networks

The collector area and the solar storage tank volume display the greatest sensitivity with respect to the degree of solar coverage and the level of the capital costs. For this reason, the first step will be to determine these parameters.



To avoid detailed simulation calculations in the pre-planning phase, generally applicable dimensioning nomograms were developed which allow a rapid and reliable estimate of the collector area and the solar storage tank volume in connection with two-pipe networks (Fink et al., 2002). Apart from the key data for the solar thermal system, the degree of solar coverage to be expected for the project in question and the specific solar yield can also be read off. The basic data for the nomograms are obtained from numerous simulation calculations of overall solar-supported heating networks in the TRNSYS simulation environment. The calculation results are very reliable since they were subjected to extensive validation with measurements from a large number of different systems.

The nomograms have the advantage that if the annual heating requirements for domestic hot water and the space heating supply are already known, the key data for the solar thermal system can be determined.

To simplify the use of nomograms, the "utilisation ratio" is defined as an important auxiliary characteristic. This is a measure for the dimensioning of solar thermal systems and describes the ratio of annual consumption (in kWh) to the collector area in m^2 , see equation 17.

Equation 17:

[Empty rectangular box]

 _VP_EQN_20.GIF  _V...

It should be remembered that the following nomograms are only suitable for the design of solar thermal systems in multi-storey residential buildings since the ratio of domestic hot water to space heating requirements was determined in accordance with average Austrian residential buildings.

Important framework conditions used as a basis:

- Heat distribution networks and operating temperatures in accordance with the principle of two-pipe networks
- Location in Graz (hourly mean values generated from monthly mean values from 1991 to 1999)
- South orientation of collector area
- Inclination of collector area 45°
- Flat collector ($c_0=0.8$, $c_1= 3.5 \text{ W/m}^2\text{K}$, $c_2= 0.015 \text{ W/m}^2\text{K}^2$)

8.1.1.1

Dimensioning nomogram with defined specific solar storage volume

In the conditions mentioned above, the degree of solar coverage and the specific solar yield were plotted versus the utilisation in Figure 91. High levels of utilisation signify low degrees of solar coverage and vice versa. The specific yield shows the well known behaviour running contrary to the degree of solar coverage. Two dimensioning approaches were pursued in practice:

Dimensioning for optimum cost-to-benefit ratio

Particularly, in multi-storey residential buildings economic considerations dominate, which is the reason why systems should be designed in accordance with the optimum ratio of cost-to-benefit. This is shown in Figure 91 by the area marked in orange and signifies degrees of solar coverage in the overall heating requirements of between 12 and 20%. Solar thermal systems dimensioned in accordance with these aspects rarely reach the stagnation state even in summer, which allows optimum utilisation of the system with the shortest possible standstill times. Degrees of solar coverage of less than ten percent are outside the cost-to-benefit optimum since the (slight) rise in the specific yield does not make up for the specific higher system costs of a smaller solar thermal system and would thus lead to higher solar heating prices.

The recommended specific gross collector area per person is around 0.9 m^2 for an overall degree of coverage of 12% and 1.4 m^2 (table 5) for an overall degree of coverage of 20%.

Dimensioning for almost 100% coverage in the summer

This approach to dimensioning is welcome from an ecological point of view since the solar thermal system takes over almost 100% coverage of domestic hot water requirements in the sunny months. The conventional heat generator can therefore be switched off in this period. As a rule, this can be achieved by utilising less than 950 kWh/a per m² of the gross collector area (see the broken orange line in Figure 91).

The specific gross collector area required for almost 100% coverage in the summer is around 2 m² per person (Table 5). This corresponds roughly to the usual dimensioning for solar thermal plants in single-family homes.

Desired design	Degree of solar coverage [%]	Gross collector area [m ² per person]
Dimensioning for cost/benefit optimum	approx. 12	0.9
	approx. 20	1.4
Dimensioning with almost 100% coverage in the summer	approx. 28	2

Table 5: Dimensioning guidelines depending on degree of solar coverage

Handling the nomogram

- Determination of degree of solar coverage

Now that the annual heating requirements for domestic hot water and space heat have been determined on the basis of Section 5, the utilisation rate for a concrete planning project can be calculated by dividing this value by the gross collector area. If a vertical line is drawn through the point of the determined rate of utilisation, then a point intersecting with the course of the degree of solar coverage is obtained and the value can then be read off on the left ordinate. The same is true when ascertaining the specific yield on the right ordinate.

- Determination of gross collector area

If a desired degree of solar coverage constitutes the starting situation then a horizontal line can be placed at the corresponding height. The point intersecting with the course of the curve of the degree of solar coverage then allows the necessary utilisation to be read off on the abscissa. The necessary gross collector area is obtained by dividing the annual heating requirements for domestic hot water and space heating by the utilisation rate. The solar storage tank volume of 50 l/m² is directly proportional in this nomogram to the gross collector area.

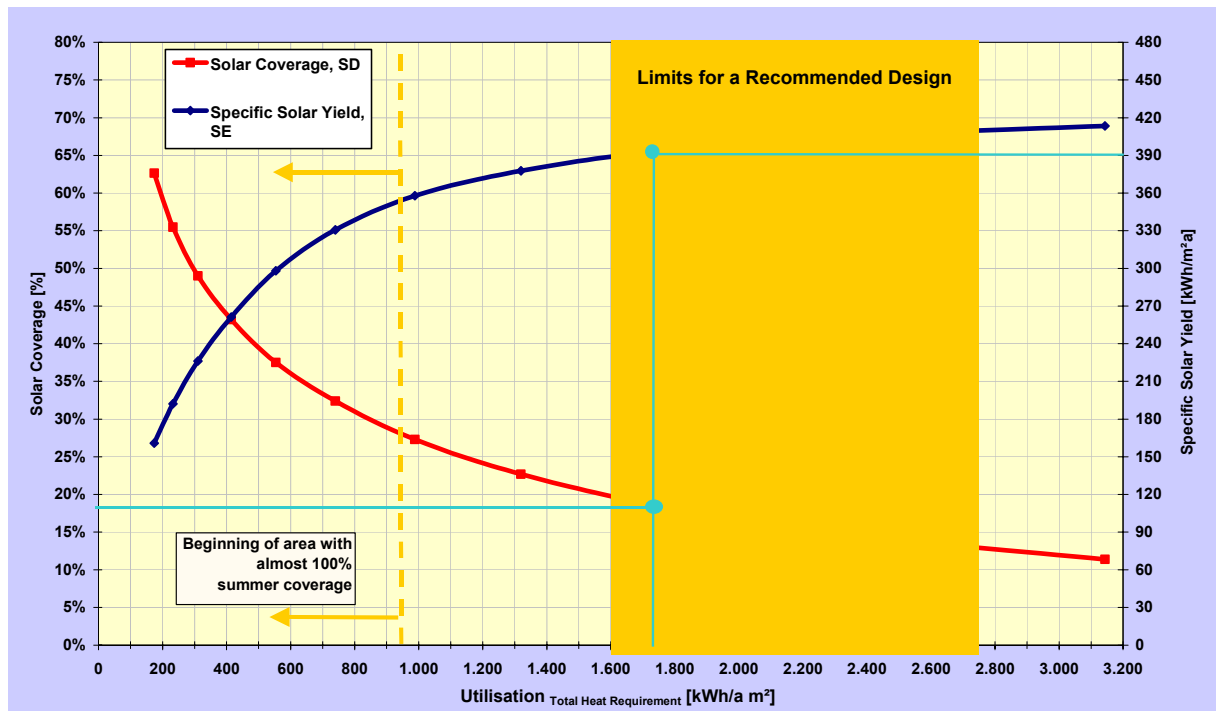

Figure 91: Nomogram to determine the gross collector area and the degree of solar coverage and at the same time ascertaining the specific yield. The graph is based on a specific storage tank volume of 50 litres per m^2 gross collector area. The dark yellow area shows the limits for a recommended design. Loads exceed 950 kWh/a and m^2 gross collector area (total solar coverage over 30%) can close to achieve a 100% solar coverage (light green area). The green lines are help lines for a dimensioning example.

Example:

Multi-storey residential building with 20 residential units

Heating energy requirements: approx. $120,000 \text{ kWh/a}$

Domestic hot water requirements: approximately $32,000 \text{ kWh/a}$

Overall heat requirements: approx. $152,000 \text{ kWh/a}$

Desired degree of solar coverage of overall annual heat requirements: approx. 18%

Steps:

1. Determination of utilisation with the desired degree of solar coverage of 18%.

A horizontal line is placed through the 18% mark on the left ordinate (degree of solar coverage). A vertical line through the intersecting point of the previously drawn horizontal line with the course of the degree of solar coverage (red line), allows the utilisation to be read off on the abscissa.

Reading value for utilisation: approx. 1,750 kWh/m² of collector area and year

2. Determination of collector area required

The overall heating requirements (152,000 kWh/a) are divided by the utilisation determined in step 1 (1,750 kWh/m² a). The result is the gross collector area.

 _VP_EQN_23.GIF

 _VP_EQN_24.GIF

To obtain 18% solar coverage, the necessary gross collector area would have to be around 87 m².

3. Determination of solar storage tank volume

This nomogram is based on a specific solar storage tank volume of 50 litres for each m². If the calculated gross collector area is multiplied by the specific storage tank volume, the overall solar storage tank volume is obtained.

$$\text{Solar storage tank volume} = 87 \text{ [m}^2\text{]} \times 50 \text{ [l/m}^2\text{]} = 4,350 \text{ l}$$

The solar storage tank volume required is around 4,350 litres.

4. Determination of specific solar yield

The specific solar yield to be expected can be read off at the point of intersection of the vertical lines through the utilisation (1,750 kWh/m²a) with the blue line.

In this example, an annual specific solar yield of around 390 kWh can be attained per m² of gross collector area.

The solar storage tank volume does not influence the degree of solar coverage to the same extent as the collector area. For this reason the nomogram is based (Figure 91) on a set specific solar storage tank volume with 50 litres per m² of gross collector area. This value has proved to be very favourable for solar thermal systems designed with regard to an optimum cost-to-benefit ratio. If solar thermal systems are to be designed with higher degrees of solar coverage it is recommended that larger specific solar storage tank volumes should be selected.

Dimensioning nomogram with variable specific solar storage volume

The nomogram in Figure 92 can be used to determine the influence of the solar storage tank volume on the degree of solar coverage. Via the auxiliary characteristic for "utilisation" this nomogram allows the flexible and generally applicable selection of gross collector area and solar storage tank volume in connection with the degree of solar coverage. For degrees of solar coverage in the cost/benefit optimum (12 to 20%) specific solar storage tank volumes from 40 to 70 l/m² can be recommended. If higher degrees of solar coverage (20 to 35%) are desired, specific solar storage tank volumes of 60 to 100 l/m² have proved to be favourable.

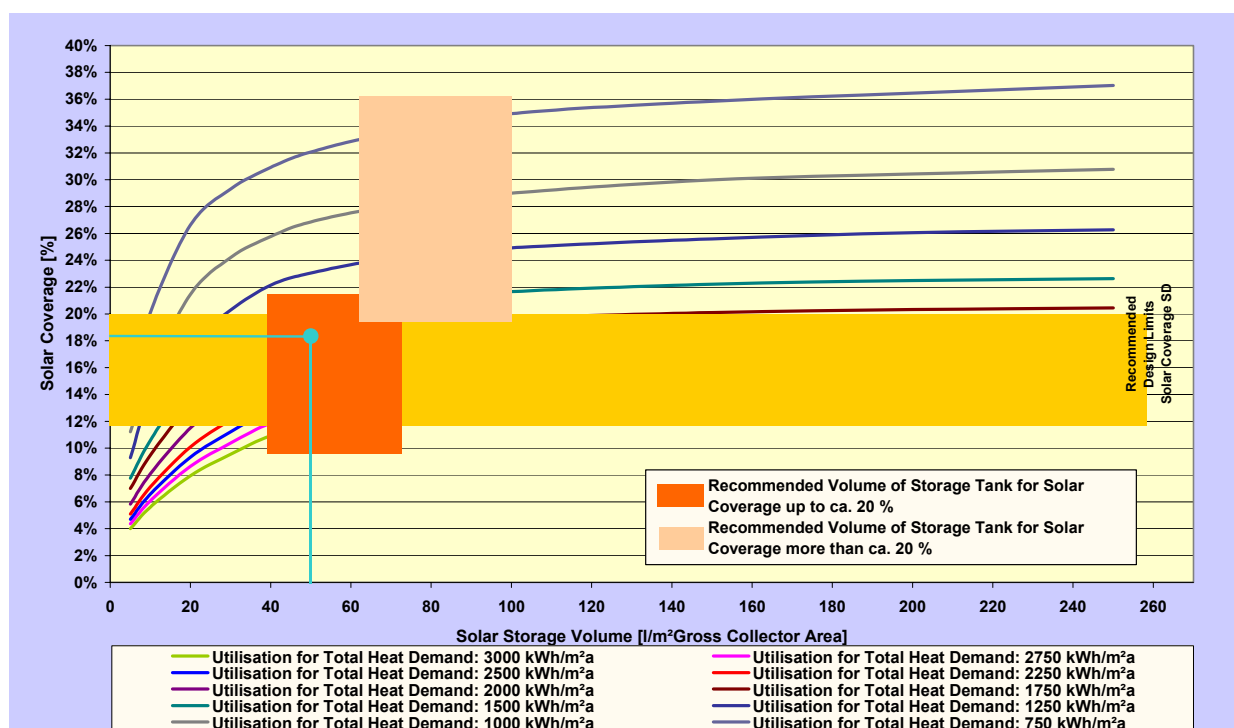

Figure 92: Nomogram to determine the gross collector area and the volume of the storage tank in relation to the solar coverage. The dark yellow area shows the recommended design limits in the cost-benefit optimisation. The sensible areas to determine the specific volume of the storage tank depend on the solar coverage and are shown as rectangles. The green lines are help lines for a dimensioning example.

Handling the nomogram

If a desired degree of solar coverage represents the situation at the start, then a horizontal line can be placed through this value. The point intersecting with the vertical line through the selected specific solar storage tank volume gives the utilisation load. This can be determined as a function of the location with regard to the utilisation curves. If the overall heat requirements determined in Section 5 are divided by the utilisation this results in the gross collector area required.

Example:

Determination of gross collector area for the example in Section 8.1.1.1 with the nomogram in Figure 92:

Multi-storey residential buildings with 20 residential units

Heating energy requirements: approx. 120,000 kWh/a

Domestic hot water requirements: approx. 32,000 kWh/a

Overall energy requirements: approx. 152,000 kWh/a

Desired solar coverage of overall annual energy requirements: approx. 18%

Steps:

1. *Selection of specific solar storage tank volume*

A specific solar storage tank volume of 40 to 70 l/m² is recommended for the desired solar coverage of 18%. From this range a volume of 50 l/m² is selected.

2. *Determination of utilisation*

If a vertical line is placed through the selected specific solar storage tank volume of 50 l/m² and a horizontal line through the desired solar coverage of 18%, the utilisation can be determined by the point of intersection. Depending on the position of the point of intersection to the starting points plotted for several utilisations, the applicable utilisation can be estimated. In this concrete example, the point of intersection lies exactly on the utilisation line at 1,750 kWh/a×m².

3. *Determination of collector area*

The required gross collector area can be obtained by dividing the overall heat requirements by the utilisation.

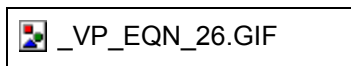
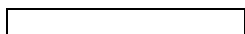

To achieve a solar coverage of 18%, the necessary gross collector area would have to be about 87 m².

4. *Determination of overall storage tank volume*

The overall storage tank volume is obtained by multiplying the calculated gross collector area by the selected specific storage tank volume:

$$\text{Solar storage tank volume} = 87 \text{ [m}^2\text{]} \times 50 \text{ [l/m}^2\text{]} = 4,350 \text{ l}$$

The solar storage tank volume required is about 4,350 litres.

Since the same specific solar storage tank volume was selected in this example as in Section 8.1.1.1, the same result was achieved of 87 m².

If the limits of the range of the recommended specific solar storage tank volume (40 l/m² or 70 l/m²) are set for the same example then in the case of 40 l/m² this would result in a required collector area of 92m² and 80 m² in the case of 70 l/m². The target value is a solar coverage of 18%.

8.1.1.3

Determining the influence of the inclination and orientation of the collector area

The nomograms depicted in Sections 8.1.1.1 and 8.1.1.2 are based on a defined collector basic inclination (45°) and basic orientation (to the south) of the collector area. In practice, areas with a 45° inclination and orientation to the south are not always available. This is why the result of the dimensioning nomograms has to be adjusted to the real orientation with respect to the degree of solar coverage.

The collector inclination is clearly related to the solar coverage. If solar thermal systems dimensioned in accordance with the cost-to-benefit optimum reveal advantages with smaller angles of inclination (30 to 45°) then the optimum inclinations for solar thermal systems with higher solar coverage involve larger inclination angles (40 to 55°).

Desired design	Solar coverage	Recommended collector inclination	Recommended collector orientation
Dimensioning for cost-benefit optimum	approx. 12%	25 to 40°	If possible to the south, ±45° to the east or west is tolerable
	approx. 20%	30 to 45°	If possible to the south, ±45° to the east or west is tolerable
Dimensioning with almost 100% summer solar coverage	approx. 30%	40 to 55°	If possible to the south, ±45° to the east or west is tolerable

Table 6: Ranges of recommended angles of inclination and orientations of collector areas as a function of solar coverage

A correction nomogram was prepared for the example of solar-supported heating networks of two-pipe design in order to observe the influences of collector inclination angle and the collector orientation in a combined manner (Figure 93).

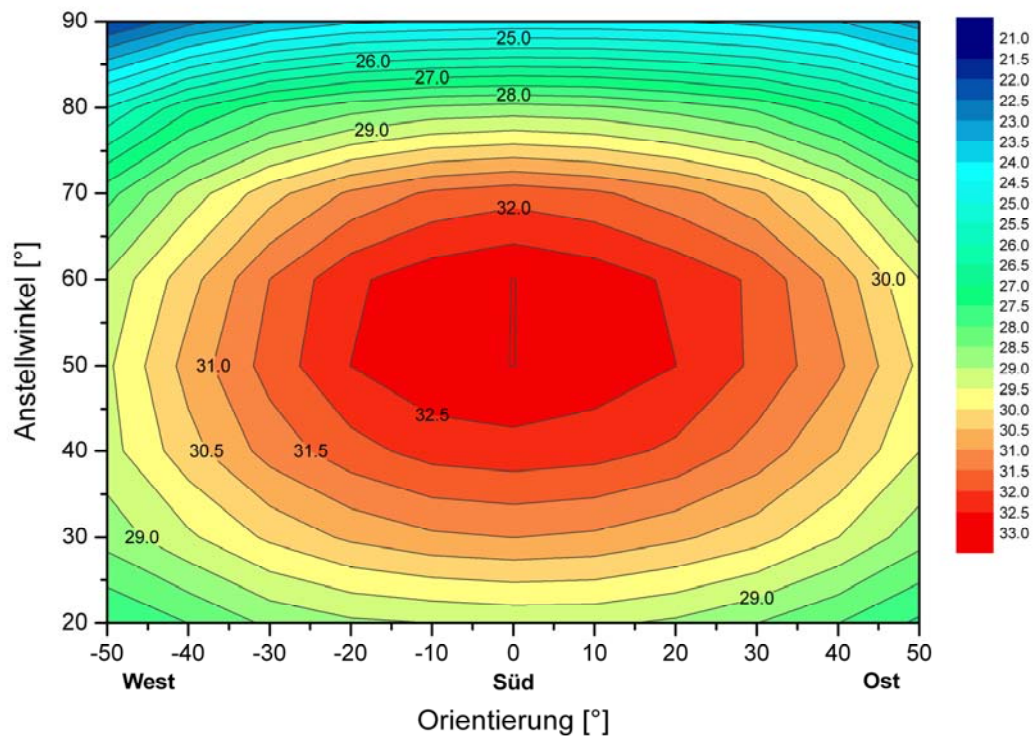

Figure 93: Nomogram to determine the reduction of the solar coverage in relation to the actual inclination and the actual orientation (valid for solar coverage around 30%).

With regard to the dimensioning approach, a solar coverage of around 30% was used as a basis.

In this diagram, the reduction in the maximum solar coverage is determined by means of deviations in the inclination or orientation. Within the rings of the same colour almost identical degrees of solar coverage are found. If the maximum solar coverage is 33% (50° inclination, orientation to the south), then, for example, this is reduced to around 31.5% for an orientation of 30° east and a collector inclination of 40°.

8.2

Dimensioning for security of supply

In modern heat supply systems in multi-storey residential buildings it has to be possible to meet the individual heating requirements of each occupant every hour of the day and all year round (domestic hot water and space heating). This is known as "security of supply".

Whether the supply is secure for a solar-supported heat supply system or not has absolutely nothing to do with the solar thermal system. Rather the security of supply depends on the interaction between the conventional heat generator, the preparation of domestic hot water and the heat distribution network. Thus, for example, security of supply for systems with a separate supply of domestic hot water and space heating (four-pipe networks) as well as systems with domestic hot water storage tanks is relatively simple to achieve.

One special aspect must be taken into consideration for two-pipe networks with apartment heat transfer units. In this heat supply concept the domestic hot water is prepared in a decentralised manner according to the through-flow principle without the use of storage tanks. Since experience has shown that under these boundary conditions deficits in planning may arise, in this Section the interrelations will be explained and recommendations provided for practical applications.

8.2.1

Supply of space heating and domestic hot water

In dimensioning for the security of supply it is necessary to start with the maximum heating load required for space heating and requirements for domestic hot water.



Figure 94: Supply guarantee concerns every heat supply system and is no specification for solar-supported heating networks (picture source Teufel & Schwarz, Tyrol, Austria).

The heating load (Section 5.2) can be taken as the maximum performance for the space heating supply, but it is much more difficult to determine the peak load for heating domestic hot water. Apart from the maximum performance, the period of time of the highest consumption also plays a decisive role. DIN 4708 deals with this problem in detail.

Particularly in multi-storey residential buildings, an enormous output would be necessary if all the flats drew hot water simultaneously thus far exceeding the heating. Fortunately, the statistical probability factor applies here which considerably evens out the performance peaks. In DIN 4708 the frequency distribution for a certain period of demand is given by the mathematical distribution laws of probability theory. This is based on so-called residential units with an average number of 3.5 people and equipped with a bath (150 l) and two other outlet points.

The distribution of frequency (period of demand 10 minutes – time for filling the bath) which occurs for the peak requirements is represented as a simultaneity factor. Figure 95 shows the curve of the simultaneity factor as a function of the number of flats in accordance with DIN 4708 (red line). If the simultaneity factor in a flat to be supplied equals 100%, then with 20 flats it is only about 20% and only around 10% for 100 flats. This means that according to the probability calculation, for example,

with 20 flats the bath is filled only in four flats at the same time. With 100 flats this amounts to only ten. This effect is used when dimensioning for the security of supply.

The fact that in DIN 4708 there are still some reserves with regard to the simultaneity factor (peak load, period of demand 10 minutes) is shown by the second curve in Figure 95 (blue line). This shows the course of the simultaneity factor on the basis of extensive measurements for the same period of demand of ten minutes.

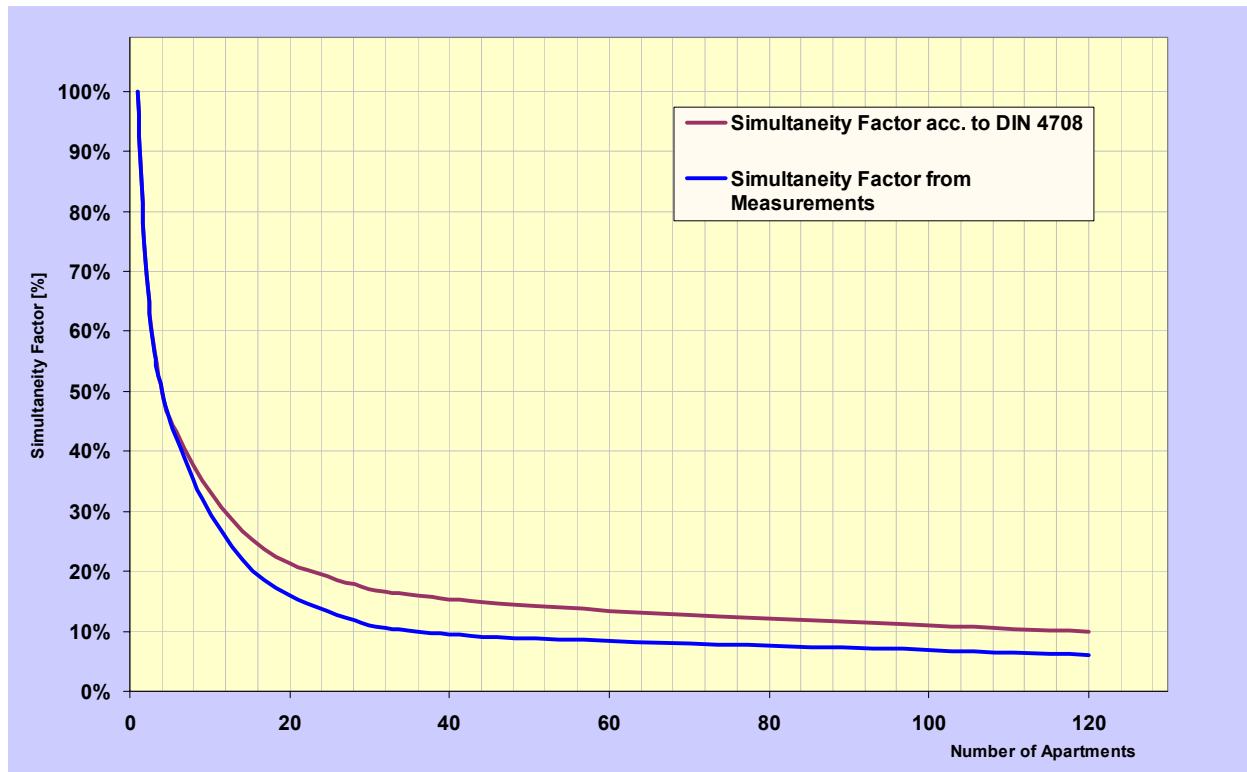

Figure 95: Simultaneity Factor according to DIN 4708 and measurements (source: Recknagel et al., 2003).

Two aspects now have to be taken into consideration separately for the dimensioning of heat supply concepts in accordance with the principle of the two-pipe network:

- Dimensioning of conventional heat generator and load equalisation storage tank to bridge longer periods of demand. Normally the maximum heat requirements of the flats (domestic hot water and space heating) are considered for a period of 180 minutes.
- Dimensioning of heat distribution network and of the network pump on the basis of the peak load for domestic hot water and the supply of space heating (period of demand 10 minutes).

8.2.2

Interaction between conventional heat generator and load equalisation storage tank

The overall maximum heat requirements can now be covered either directly via the conventional heat generator (boiler) or via a combined peak supply using the boiler and the load equalisation storage tank. Thus great significance is attached to the dimensioning of the nominal performance of the boiler and the volume of the load equalisation storage tank. In accordance with the respective prevailing conditions (type of boiler, costs, need for space, etc.) the boiler can either be enlarged or the standby volume in the energy storage tank increased.

On the basis of the maximum heat requirements defined in DIN 4708 for a demand period of 180 minutes, the method of calculating the volume of the load equalisation storage tank and the standby volume that is kept at a constant temperature is presented in the following. All volumes refer to supply temperatures of 65°C.

[litres at 65°C] *Equation 18*

V_{Ber} Overall standby volume [litres at 65°C]

V_{RW} Volume for secure supply of space heating [litres at 65°C]

V_{BW} Volume for secure supply of domestic hot water [litres at 65°C]

V_{NH} Volume which boiler contributes to the supply of heat [litres at 65°C]

In determining the volume required for the secure supply of space heating (V_{RW}) attention has to be paid to a special condition which applies for apartment heat transfer units. In the flats in which domestic hot water is being drawn there is practically no space heating supply for these short periods. This is performed automatically via the basic hydraulic design of the apartment heat transfer units. In dimensioning the security of supply this has the advantage that the space heating requirements can be reduced by those flats in which domestic hot water is being drawn.

[litres at 65°C] *Equation 19*

$V_{RW_{180min}}$ Overall volume for the secure supply of space heating over a period of 180 minutes [litres at 65°C]

$V_{RW_{red}}$ Reduction volume due to the omission of those flats in which domestic hot water is being drawn for a period of 180 minutes [litres at 65°C]

Whereby $V_{RW_{180min}}$ und $V_{RW_{red}}$ are calculated as follows:

[litres at 65°C] *Equation 20*

[litres at 65°C] *Equation 21*

Heating load of the entire multi-storey residential building [kW]

c_p Specific heat capacity of water [kJ/ltrK]

ΔT_{RW} Temperature difference in supply of space heating [K]

Heating load of a residential unit [kW]

Q_{180min} demand for domestic hot water for a period of 180 minutes as a function of the number of flats according to DIN 4708 [kWh/3 h]

maximum output for preparation of domestic hot water in an apartment heat transfer unit [kW]

The volume required for a period of 3 hours V_{BW} at 65°C for the secure supply of domestic hot water can be determined using the following equation:

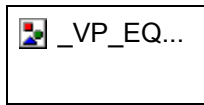

[litres at 65°C] *Equation 22*

ΔT_{BW} Temperature difference for preparation of domestic hot water [K]

The volume that the boiler contributes to the supply of heat within the three-hour demand period can be calculated as follows:

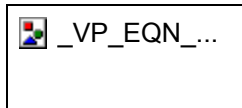

[litres at 65°C] *Equation 23*

ΔT_{NH} Temperature difference when loading the energy storage tank [K]

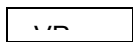

Nominal performance of boiler [kW]

Figure 96 shows the calculated results for the necessary storage volume as a function of the number of flats using the calculation method given above (blue and green line). The boiler output was taken into consideration at the height of the heating load (blue line) and once again with an additional 20% (green line). The influence of the boiler output can be clearly recognised. If, for example, the boiler was designed precisely for the heating load when supplying 30 flats, then around 4,000 l of standby volume would be required. A 20% larger boiler would only require about 2,300 l more.

In addition to the theoretical calculations in accordance with DIN 4708, the recommended standby volume from two suppliers of apartment heat transfer units is shown in Figure 96. Assuming that the boiler output is the same as the heating load, the dimensioning recommendations of the two companies Redan (Redan, 2003) and Logotherm (Logotherm, 2003) are much lower than the calculated results obtained from the standard. The companies assert that these great differences are due to the very high level of security in the standard, and for their part they refer to hundreds of heat supply systems of this kind which they have supplied as well as to the peak consumption measurements in multi-storey residential buildings.

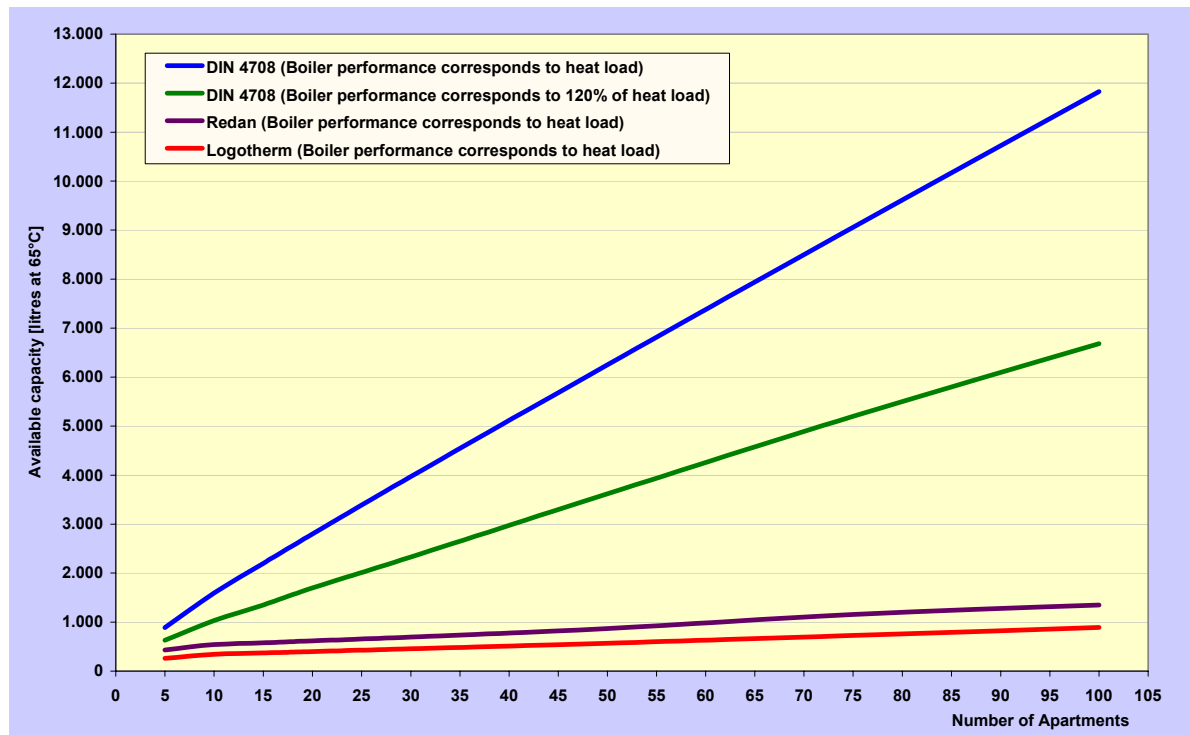

Figure 96: Necessary available volume capacity depending on the number of apartment units. Comparing the DIN 4708 (blue and green line) with the dimensioning recommendations. This diagram is based on: 3 kW heat demand per apartment, 36 kW maximum domestic hot water demand per apartment, 40 K as ΔT for the hot water preparation, 25 K as ΔT for the heating boiler circulation.

Another factor leading to the difference between theory and practise is the lack of consideration of the heat distribution network as a storage tank. In large multi-storey residential buildings, in particular, the heat distribution network accounts for many hundreds of litres, which was not taken into consideration in the theoretical calculation in accordance with DIN 4708. For this reason it would very probably be possible to do without load equalisation storage tanks in multi-storey residential buildings of more than 50 flats according to information provided by Redan.

Since risks still have to be taken into consideration, such as for example the different start-up times of boilers (the time the boilers need to produce the nominal output), load equalisation storage tanks are recommended even with large multi-storey residential buildings. In addition, the integration of the boiler via a load equalisation storage tank produces advantages since this also functions as a hydraulic switch.

In practice, this comparison means that due to the great experience of the suppliers of apartment heat transfer units, the dimensioning of the standby volume should be performed in accordance with information provided by the respective manufacturer or even in close co-operation with the latter.

8.2.2.1

Determining the overall volume of the energy storage unit

In hydraulic terms, the standby volume required should be ensured in accordance with Figure 97. It should be remembered that both the standby volume and the switching volume have to be added to the solar storage tank volume determined in Section 8.1.

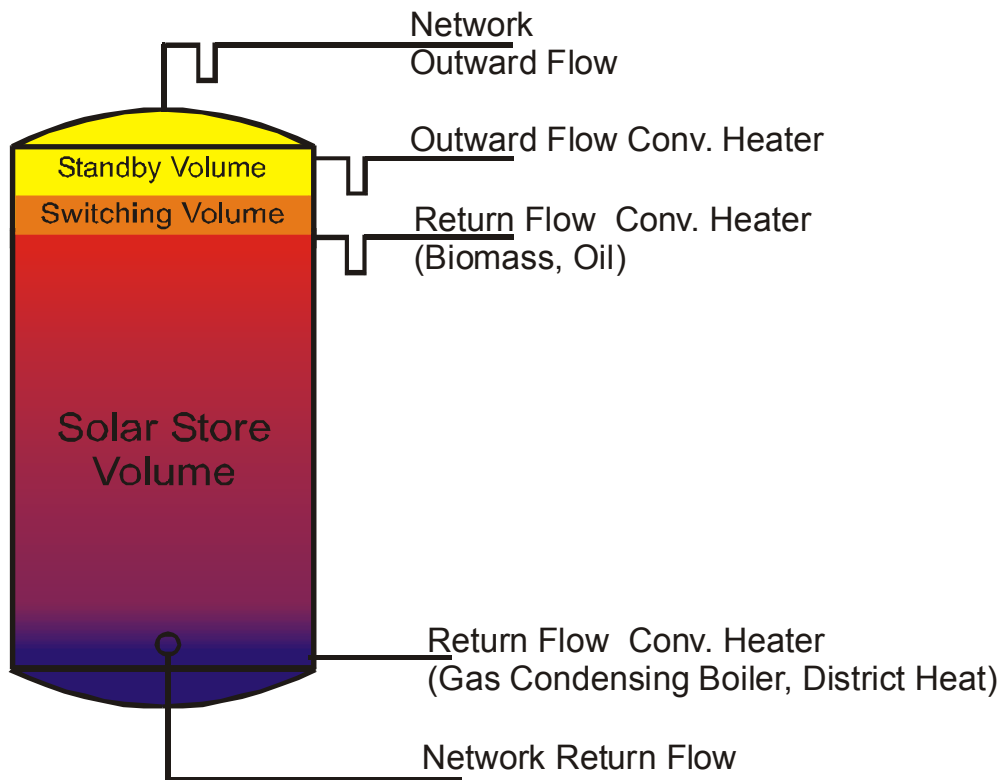

Figure 97: Block diagram showing the storage management in solar-supported heat supply concepts with the two-pipe network principle.

Standby volume

This volume must be kept at least at the network supply temperature to ensure the security of supply for two-pipe network heat supply systems. The main task is to cover peak loads over a longer period of time and to bridge the start-up time of the conventional heat generator. The volume is dimensioned as described in Section 8.2.2.

Switching volume

Temperature sensors at the top and lower end of the switching volume determine the switch-on and switch-off time of the conventional heat generator. The same process can also be performed with a temperature sensor and a corresponding switching hysteresis. The switching volume in the energy storage tank defines its running time as a function of the current heat requirements and the output of the conventional heat generator and prevents clock-mode operation.

Solar storage tank volume

The dimensioning of the solar storage tank volume has already been dealt with in Section 8.1. It is important that the solar storage tank volume is exclusively made available to the solar thermal system and is not heated by the conventional heat generator.

Conventional heat generator

In dimensioning the overall volumes, attention should be paid to the start-up time of the boiler which can differ quite considerably depending on boiler mass.

8.2.3

Dimensioning of heat distribution network

A design criterion for the heating distribution network is the maximum peak load (demand period, 10 minutes, in accordance with DIN 4708). An adequate supply of domestic hot water and space heating to each flat must be implemented with due consideration to the lowest possible loss in pressure (low electricity requirements for the operation of circulation pumps) and lower flow speeds in the strings (no noise). These aspects demand an appropriate design, whose basic methodology is presented in the following. This assumes knowledge of the following framework conditions:

- Output of water heater in an apartment heat transfer unit (as a rule 36 kW)
- Overall heating load and average heating load of a flat
- Simultaneity factor according to DIN 4708 (peak consumption in ten minutes)
- System temperatures (network supply, network return). The heating of domestic hot water is normally performed at a network-side temperature level of 65/25 and the supply of space heating at 65/40.
- In flats in which domestic hot water is being drawn, only a small (negligible) amount of energy is available for the supply of space heating.

$$\boxed{\dots\dots\dots} \quad [\text{litres/h}] \quad \text{Equation 24}$$

$\boxed{\dots}$ maximum necessary volume flow in the network [litres/h]

$\boxed{\dots}$ maximum volume flow necessary for the preparation of domestic hot water only with due consideration of the simultaneity factor in accordance with DIN 4708, demand period 10 minutes (see Figure 95) [litres/h]

$\boxed{\dots}$ maximum volume flow necessary for supply of space heating only with due consideration to reduced supply of space heating in the flats where domestic hot water is being heated [litres/h]

Whereby $\boxed{\dots}$ and $\boxed{\dots}$ are defined as follows:

$$\boxed{\text{VP_EQN_43\dots}} \quad [\text{litres/h}] \quad \text{Equation 25}$$

$\boxed{\dots}$ maximum output of domestic hot water preparation in an apartment heat transfer unit [kW]

n_{WE} number of residential units

f_{GI} simultaneity factor in accordance with DIN 4708 for the peak requirement period of ten minutes

c_p specific heat capacity of water [kJ/ltrK]

$\boxed{\dots}$ temperature difference in domestic hot water preparation [K]

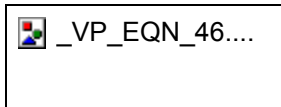

[litres/h] **Equation 26**

heating load of overall multi-storey residential building [kW]

ΔT_{RW} temperature difference in the supply of space heating [K]

Determination of the maximum necessary volume flow has to be performed across the entire heat distribution network. This means that after each string point of intersection (connected with a reduction in the remaining number of flats) a new simultaneity factor is determined and this procedure has to be repeated until only the flat furthest away remains (simultaneity factor is 1).

9

Minimisation of heat losses

To achieve the highest possible system efficiencies, the avoidance, or reduction of heat losses is imperative. Numerous measuring tests conducted on solar-supported heat supply systems have shown that this aspect is not given enough attention in most systems. In this respect, the minimisation of heat losses is not necessarily a specific requirement of solar thermal systems but rather affects all heat supply systems.

On the one hand, there is a need to concentrate attention on the conceptional, system-related avoidance of lossy surfaces and, on the other hand, to focus on the minimisation of heat losses of lossy surfaces by greater insulation thicknesses and high-quality installation work.

9.1

Energy storage tanks

Energy storage tanks in solar-supported heat supply concepts should display good temperature stratification behaviour from an energy-related point of view and, on the other hand, a small surface area to avoid heat losses. An important evaluation figure in this respect is the ratio of height (H) and diameter (D) of a storage tank. Practice has shown that with ratios (H/D) of between two and four both the demands of the temperature stratification and the limitation of lossy surfaces can be fulfilled.

9.1.1

Heat losses from energy storage tanks

Numerous measurements on solar-supported heat supply systems have revealed a high proportion of energy losses from storage tanks in relation to overall heating requirements (in extreme cases up to 30%). There was an alarming deviation in the measurements between theoretical and actual heat losses. This effect is clearly illustrated in Figure 98. Here the theoretical influence of the thermal thickness is presented as a function of solar coverage in comparison to the measuring results. The reference system was defined as an annual degree of solar coverage of the overall heating requirements of 22% (50 m² collector area, 3.5 m³ energy storage tank volume) and a solar coverage of 50% (220 m² collector area, 11.5 m³ energy storage tank volume).

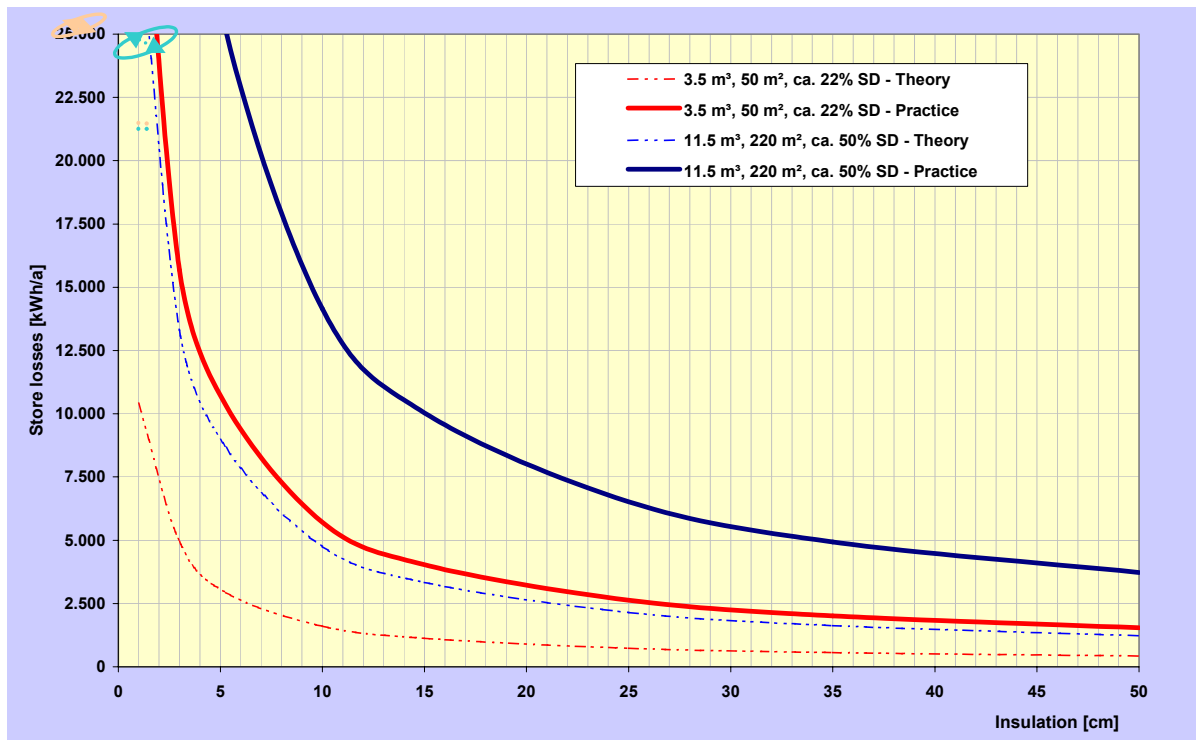

Figure 98: Isolation material depending on the solar coverage – differences between theory and practice. An insulation material with the heat conductivity of 0,042 W/mK was used (Heimrath, 2004).

Both with regard to the theoretical results and the measuring results, the degree of solar coverage revealed a great influence on the heat losses. Theoretical calculations for storage tank sizes of between 3.5 and 11.5 m³ yielded insulation thicknesses between 10 and 15 cm as an energetic and economic optimum. The consideration of practical correction factors (systems already constructed on the basis of the measuring results) revealed optimum insulation thicknesses between 20 and 25 cm for the example illustrated.

These great differences between theory and practice are quite clearly explained by the fact that the product and design quality of storage tank insulation and pipe penetrations are as a rule not optimal:

- In practice, the quality of the thermal insulation is far removed from what is feasible. Normally air pockets form between the storage tank cover and the insulation layer. This effect combined with leaks in the insulating material connections leads to a chimney effect and thus accelerated unloading of the storage tank. This is true both of industrially manufactured thermal insulation coats (small storage tank) as well as of thermal insulation to be applied individually for large storage tanks (rock wool mats with bright polished sheet covering).
- The thermal insulation coat is penetrated at numerous locations by pipe connections. The incorrect design of these penetrations through the insulation sheath encourages the above-mentioned chimney effect.

It should be remembered that not only does the increase in insulating thickness reduce heating losses from energy storage tanks, but in future projects maximum attention should also be given to the processing of thermal materials and the design of the pipe penetrations through the insulation cover.

For the storage tank sizes commonly used in solar thermal systems in multi-storey residential buildings insulation thicknesses of at least 20 cm are recommended.

In addition to the aspects mentioned above, circulation within the pipes of the connected pipework increases heat losses from energy storage tanks as a result of increasing the lossy surface area. This

can be alleviated by installing thermosiphons on all the storage tank connections in the hot area (see Figure 99).

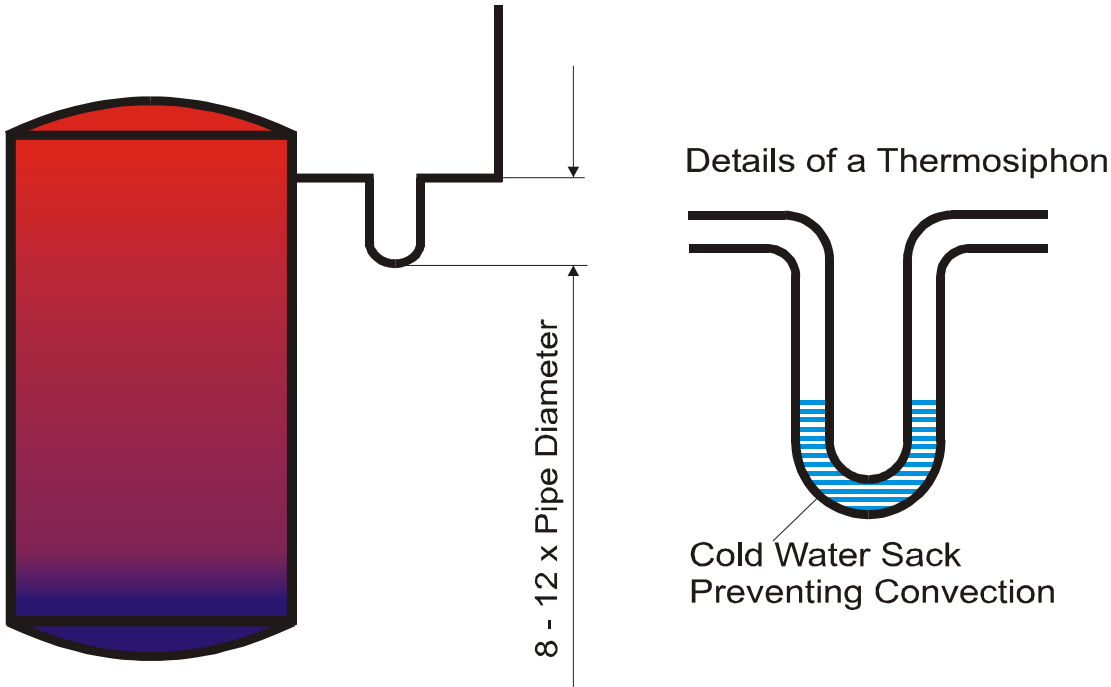

Figure 99: A thermosiphon with a depth of at least 8 times the diameter of the pipe prevents internal circulation in the pipe.

9.1.2

Single-storage-unit systems instead of multi-storage-unit systems

According to experience, batteries of storage tanks are frequently used in solar-supported heat supply concepts (both potable water storage tank and the uncoated steel storage tank) as the energy storage unit (see Figure 101). This design means a maximisation of the ratio of the surface and the volume and thus a large surface prone to losses. If this effect is combined with inefficient thermal insulation of the storage tank (Section 9.1.1) then the highest possible heat losses for the "energy storage" section of the system are achieved. In addition, batteries of storage tanks mean much higher investment costs than the comparable single-storage-unit systems (Figure 102).



Figure 100: Thermosiphon connections in the installation practice (picture source: AEE INTEC).



Figure 101: Multi-storage-unit systems result in heat losses, not only in solar thermal applications, but also in conventional heating systems (picture source: AEE INTEC).



Figure 102: Single-storage-unit systems with thoroughly performed heat insulation reduce the heat losses drastically.

As already mentioned in Section 6.4, the size and the arrangement of the energy storage tank must be taken into consideration at the stage of planning the building so that the foundation plates are correspondingly lowered and the energy storage tank can be installed before the cellar ceiling is in place.

Likewise manufacturers are also able to weld large storage tanks on site, which leads to a more efficient overall result from an economic point of view than with multiple storage tank systems despite the higher storage tank costs.

If, however, despite all these efforts multiple storage tank systems are the only possibility to accommodate energy storage tanks in the building (particularly in existing buildings), then at least the design quality of the thermal insulation should be as high as possible and the hydraulic connection of the individual storage tanks should be performed via serial connections (Figure 103).

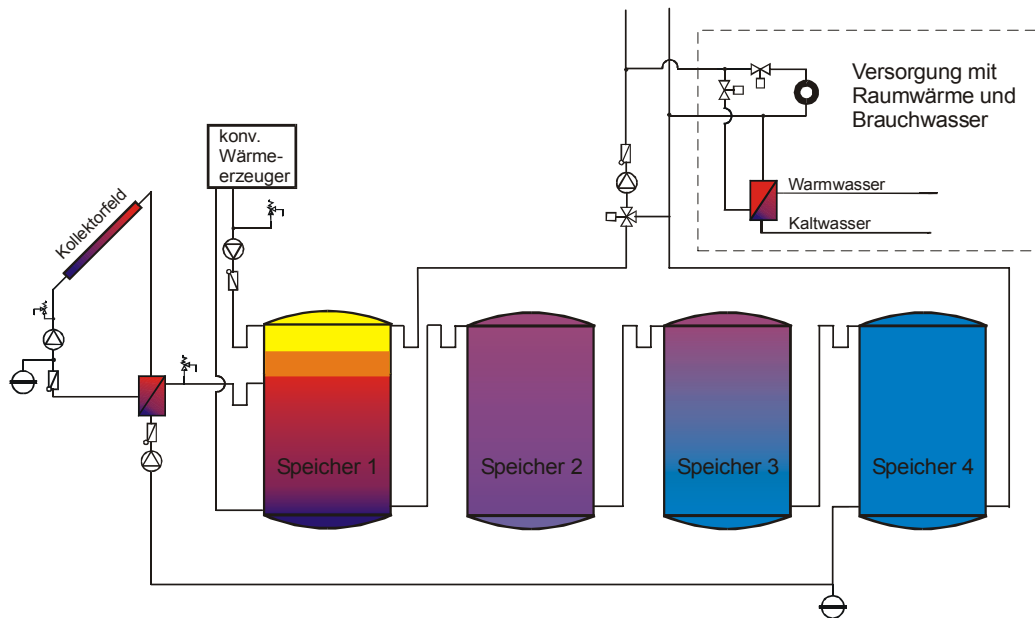

Figure 103: Should a multi-storage-unit system be inevitable (for example in an existing building), is a serial connection between the single tanks recommended.

9.2

Heat losses and pipework design

Apart from the energy storage tanks, all of the pipework for the heat supply represent a great potential for reducing heat losses. This is true both of the pipes for integrating the heat generator (solar thermal system and conventional heat generator) and for the heat distribution lines. The first priority is to avoid pipelines prone to losses. The heat losses of the remaining pipelines must then be reduced as far as possible. ÖNORM M7580 provides good standards for the thermal insulation of pipework of different dimensions in the interior of buildings (Table 7).

Pipe dimensions	Minimum insulation thicknesses for pipes ...	
	Outside [mm]	Inside [mm]
DN 15	30	20
DN 20	40	30
DN 25	40	30
DN 32	40	40
DN 40	50	40
DN 50	60	50

Table 7:

The right-hand column shows the insulation thickness recommended for pipes for the inside of buildings with average temperature differences of 40 K (ÖNORM M7580, 1985). The centre column shows the recommended insulation thicknesses for outside pipework with average temperature differences of 60 K (for example in solar thermal plants).

The theoretical relation between pipe dimensions, insulation thickness and performance loss is presented in Figure 104 for pipework inside buildings. The recommendation of the standards is indicated in this figure by the broken green line for dimensions DN10 to DN50.

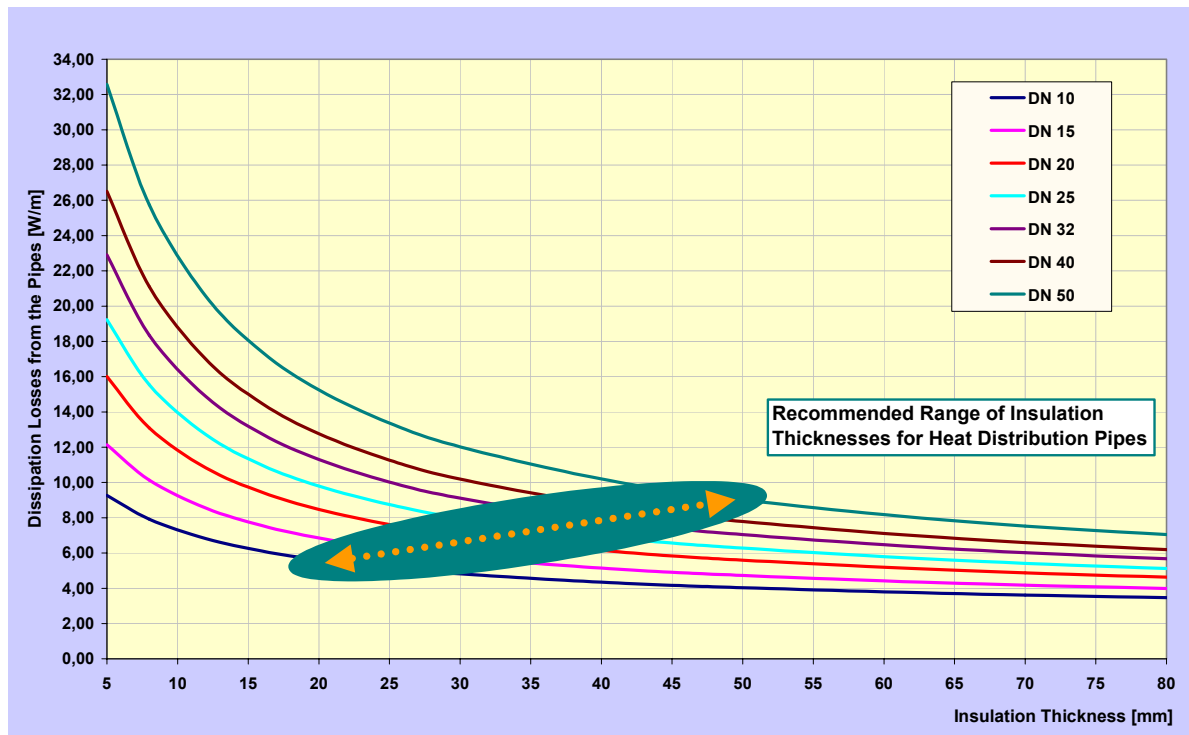

Figure 104: Theoretical dissipation losses (Watt per meter of pipe) depending on the pipe dimension and the insulation thickness (the graphic is based on: $\lambda_{insulation} = 0,04 \text{ W/mK}$, $\epsilon_{coat} = 0,5$ and a temperature deviation of 40 K between the medium and the surroundings).

According to experience, the insulation thicknesses recommended are unfortunately only very rarely used in practice, which leads to unnecessarily high heat losses in the pipes.

Particularly in the installation of solar thermal systems in multi-storey residential buildings it is frequently the case that collectors are erected on flat roofs and the hydraulic connecting lines routed on the outside. Since higher temperature differences occur here between the medium and the environment than inside buildings, pipes located outside require better insulation. Recommendations can be found in Table 7.

In addition, the thermal insulation of outside pipework is also exposed to the weather and has to be temperature-resistant up to at least 180°C especially for use in solar thermal systems. In practice, pipe shells made of rubber have proved their worth (Figure 105). Since these products are not resistant to UV rays in the long-term or to damage from animals (birds, rodents, etc.) their surface has to be protected. As shown in Figure 106 this is normally done by a conventional bright polished sheet covering. Although the insulating material rock or mineral wool is temperature-resistant it is not water-repellent which leads to pipe shells becoming completely soaked when the pipework is routed outside despite the polished sheet covering. This clearly reduces the insulating effect.



Figure 105: Pipe work for solar thermal systems, which is laid outside, should be insulated with rubber to resist temperature and water (picture source: AEE INTEC).



Figure 106: The rubber surface of the piping coat should constantly be protected against UV-light and damage from animals through a sheet-metal jacket (picture source: AEE INTEC).

Inside the building, on the other hand, the temperature-resistant insulating material rock or mineral wool can be used without any restrictions. In this respect, it is decisive that the recommended insulating thickness is used for all the heat transfer pipes and as consistently as possible. Wall and ceiling penetrations and non-insulated fittings are typical weak points.

With regard to ceiling or wall penetrations for pipes (which as a rule are designed in a non-insulated manner or with 5 mm insulating tubes) the complete insulating thickness should be used, which requires the timely planning of shafts and recesses (see Figure 107). In the event that core drillings

are required for pipework penetrations, care should be taken that the pipe insulation can be applied in the corresponding thickness.



Figure 107: No reduction or even discontinuity of insulation by penetrations in walls or ceilings.

In modern heat supply systems, insulated fittings (pumps, mixing valves, ball valves, etc.) should be standard (Figure 108). Two-pipe networks offer the possibility of dispensing with insulation in the return line due to the low return temperatures (30°C on average). However, fittings in the supply line of the heat distribution network should be insulated.



Figure 108: Insulated fittings as standard in modern heat supply systems. Exemplary insulated ball valves and pumps as well as insulated mixing valve in a multi-storey residential building.

10

Investment costs, grants and economic efficiency

The cost development of solar thermal systems in multi-storey residential buildings has been positive in recent years. On the one hand, it has been possible to further reduce collector costs as a result of largely automated production processes (Figure 109), and, on the other hand, hundreds of solar thermal systems installed in multi-storey residential buildings have increased the reliability of cost calculations, which clearly narrowed down the range of possible system costs.



Figure 109: Automatic production to the greatest extent leads to high quality and reduces the costs (picture source GREENoneTEC, Carinthia, Austria).

A common characteristic for describing costs is the specific system price. In this the investment costs for the overall solar thermal system (collector area, collector pipework, solar primary circuit, solar secondary circuit, energy storage tank including insulation, regulation, assembly, commissioning and documentation) are related to the gross collector area. On the basis of numerous projects already implemented, Figure 110 shows the range of common specific system costs plotted against the collector area. This representation shows that smaller solar thermal systems have higher specific system costs than larger solar thermal systems. The reason why the curve behaves in this way is that the system costs do not rise in direct proportion to the collector area.

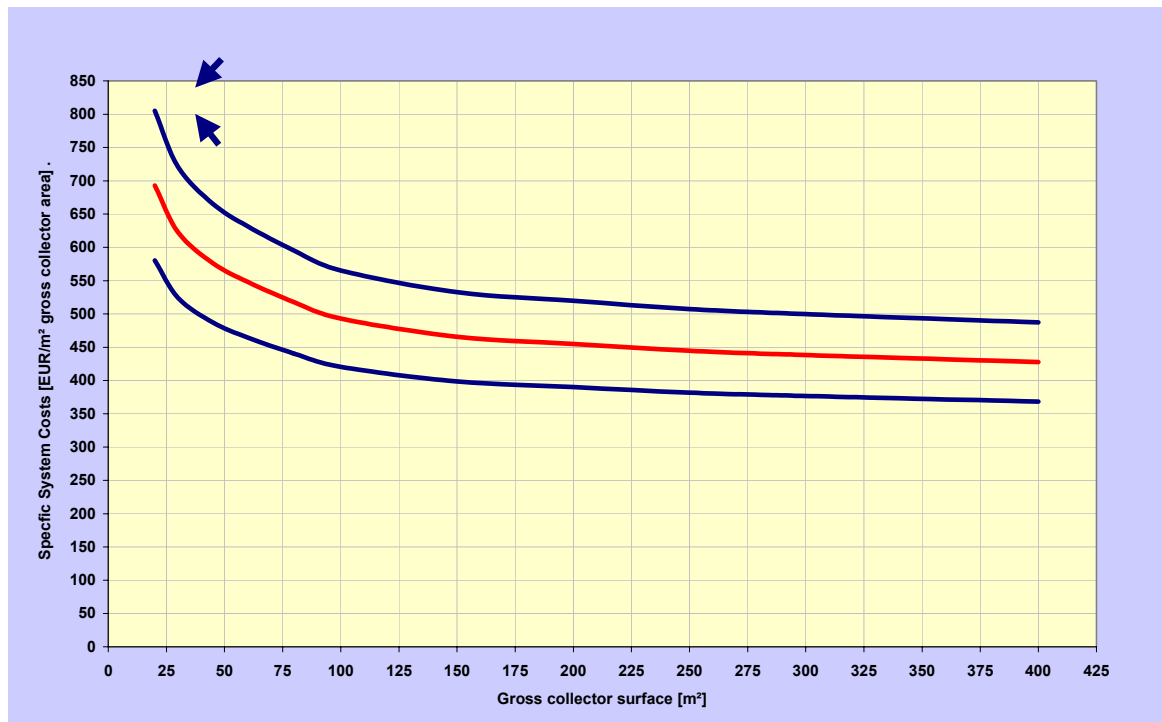

Figure 110: Progression of the specific solar thermal system over the gross collector area: the red line shows the mean system price, the two blue lines show the possible effect from the specific basic conditions of the project. The specific prices do not include taxes, planning costs or subsidies.

The range of specific system prices shown in Figure 110 is the outcome of circumstances specific to the project in addition to regional differences. Favourable boundary conditions (roof integration, single-storage-tank systems, short connecting lines, etc.) reduce the specific system price, whereas unfavourable conditions (collector erection, multiple storage tank systems, pipes laid underground or outside, long connecting lines, etc.) lead to an increase in this price. Since the difference in the system price is in the range of **€ 100 and € 200** for favourable and unfavourable framework conditions, **it is important to make the most of cost reduction potential in the early planning phase (see Section 3 "Holistic approach")**.

If the specific system costs are the most common and meaningful figure for domestic engineering managers, residential associations are much more interested in the specific costs per m² of living space. In accordance with experience, the specific additional costs for solar thermal systems are between € 15/m² and € 35/m² of living space. This means a share of the overall construction costs for the flat of around 1.5 to 3%.

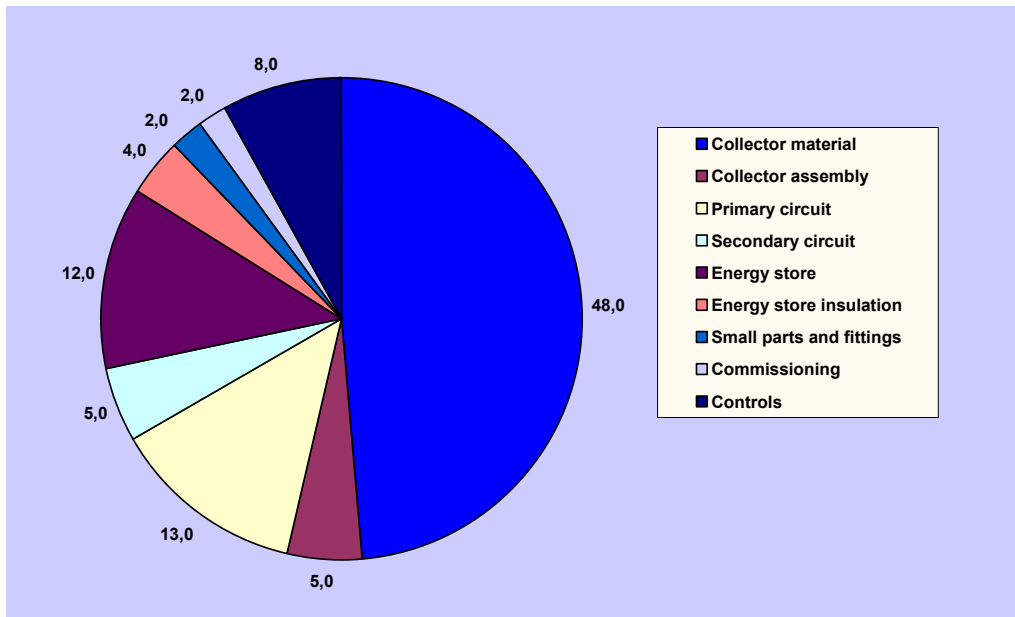

Figure 111: Average solar system costs divided in costs groups based on results from cost proposals from realised projects (exclusive taxes).

Figure 111 shows how the system costs are divided on average with regard to the solar thermal systems installed in multi-storey residential buildings in cost groups. The largest cost group in the system price is the collector, which, including installation, accounts for 50% of the investment. This is followed by the cost groups of "pipework" (primary and secondary circuit and incidentals) at around 20% and the "energy storage tank" (cost for storage tank and thermal insulation) at around 16%. Figure 112 shows the cost curve for normal energy storage tanks (without thermal insulation) as a function of storage volume.

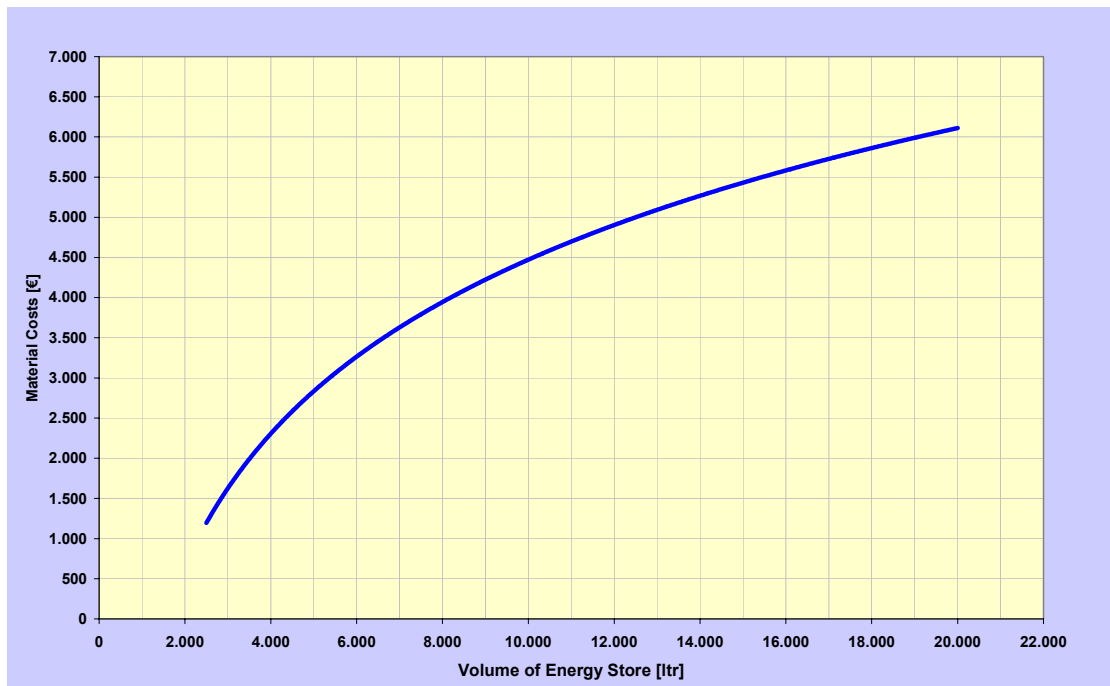

Figure 112: Progression of the costs of the energy storage tank depending on the volume based on results from cost proposals from realised projects (exclusive taxes).

Grants from the state

Great importance is attached to thermal solar systems not just by the general public but also by the state. This is demonstrated by the granting of funds for solar thermal systems in multi-storey residential buildings in practically all the Austrian federal states (EVA, 2004). The models for implementing these grants differ greatly (ranging from direct grants to annuity grants and inexpensive loans depending on whether a new building or renovation work is involved), but represent an important incentive for the implementation of solar thermal systems in multi-storey residential buildings. In addition, most towns and local authorities encourage the installation of solar thermal systems in multi-storey residential buildings.

Aspects of the economic efficiency of solar thermal systems

If solar thermal systems are dimensioned in accordance with the cost-to-benefit optimum, they achieve economic results even under present conditions in dynamic calculation models, giving due consideration to the grants mentioned above (VDI 2067, 1999). However, the extent to which economic characteristics of this kind are the ultimate measure remains a matter of doubt until the following arguments are taken into consideration in the methods applied for economic efficiency calculations:

- Increase in the price of energy as a result of resource shortages
- The cost of wars fought over the remaining fossil energy resources
- Subsidies for fossil and atomic energy
- Damage and risks arising from atomic energy
- Cost of oil tanker catastrophes
- Damage to health as a result of burning fossil energy carriers
- Damage resulting from natural disasters due to the greenhouse gas CO₂, which is released when fossil fuels are burnt
- Reduction of habitats and biodiversity as a result of irreparable climate change due to the burning of fossil fuels

If all of these aspects are taken into consideration then it can be easily seen that solar thermal systems should already be a component part of the heat supply of multi-storey residential buildings for economic reasons and for the benefit of the national economy.

11

Plant management and monitoring

It must be expected of heating systems in general that they are operated with the greatest possible effectiveness with respect to efficient use of resources and minimisation of operating costs. The same demands apply to the operation of solar thermal systems. To guarantee this some important basic working steps are necessary following careful planning and implementation:

- Careful start-up including records of the hydraulic and automatic control settings
- Subsequent adjustments based on some months of experience in operating the overall heat supply system
- Annual maintenance and service work
- Continuous monitoring via remote control with fault alarms

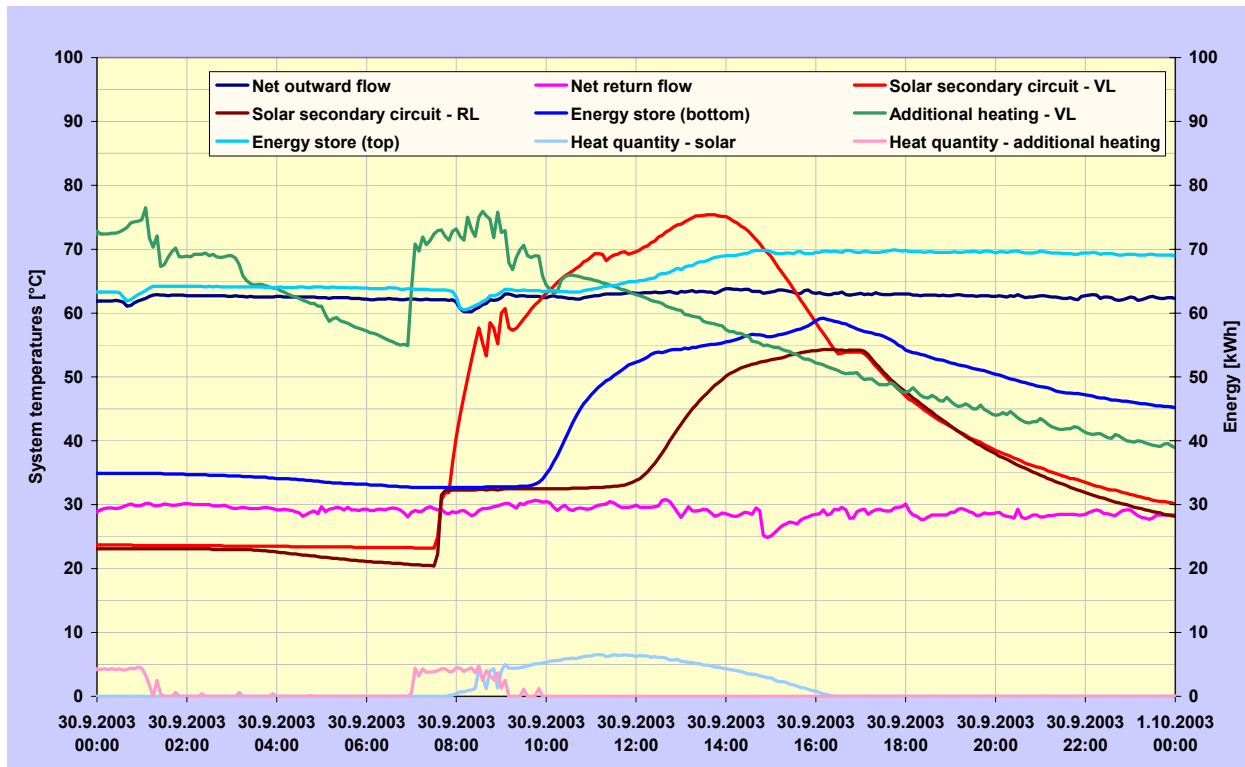

Figure 113: Important adjustments for each heating system based on temperature patterns, operation time and heat meter.

In practice, plant management is usually implemented by property managers appointed by the building's owners, a plumbing company entrusted with maintenance and service work, or a professional operator of heating systems. It is especially important that both the type and details of plant monitoring are adjusted to the technical capabilities of those entrusted with the task. For example, there is no sense in recording 5 minute mean values for all the regulating sensors and transmitting these to the maintenance company if they are not able to process this amount of data.

Basically, in practice it is recommended that monitoring equipment should be used that can control the overall heat supply system in a centralised manner (minimisation of interfaces) and which, in addition to the regulation tasks, can assume other important functions that will simplify the system management. This relates to:

- The recording of data in internal stores
- The provision of this data by remote readout
- The transmission of alarm signals
- The transmission of meter readings for energy calculations
- The change of control parameters by modem

In modern solar-supported heat supply concepts both the conventional heat generator and the solar thermal system should, in principle, have remote control monitoring. However, in practice this is frequently not the case.



Figure 114: Exemplary demonstration of a central regulation device with an integrated data logger and remote control monitoring.

System monitoring without remote readout

If no remote control monitoring is envisaged by the residential association or the system operator for reasons of cost (normally in buildings with a smaller number of flats), then it is at least recommended to use control devices which have an internal data storage unit (storage space for several weeks) and in which the system data from the last few weeks (fifteen minute average values are sufficient) can be read on site (Figure 115, left-hand column). This is an extremely important aspect when it comes to performing subsequent adjustments. It is, however, extremely disadvantageous that all monitoring activities have to be performed on site at a high cost in terms of personnel. If the system breaks down (particularly with solar thermal systems) this leads to comparatively long response times. This period of time can be reduced if an occupant on site takes responsibility for the heating and can be alerted to malfunctioning of the solar thermal system or the conventional heating system by means of a visual alarm (flashing light, display on control device, etc.).

System monitoring with remote readout

Particularly when it comes to larger residential units, systems with remote monitoring have become standard in recent years. In this respect, a basic distinction can be made between two types of control devices; on the one hand, control systems with integrated data loggers and, on the other hand, a central building control system (Figure 115, right-hand column).

In these devices all the system data can be sent and parameter changes performed via modem depending on the equipment available. This offers advantages both at the subsequent adjustment stage and in routine system monitoring. If the heat calculation is now integrated in this concept, personnel-intensive inspections can be largely eliminated. As a result of the ability to record trends, malfunctioning of the overall system can be recognised at an early stage and in this way the frequency of breakdowns can be greatly reduced. If a breakdown does occur, the response time of the system operator is considerably reduced by the remote monitoring. In this respect, the

corresponding definition of fault signals is important for all the sections of heat supply system, also including the solar thermal system. It is a disadvantage of all central building control systems that the suppliers' software is very costly and it is practically impossible to manage the system without this software.

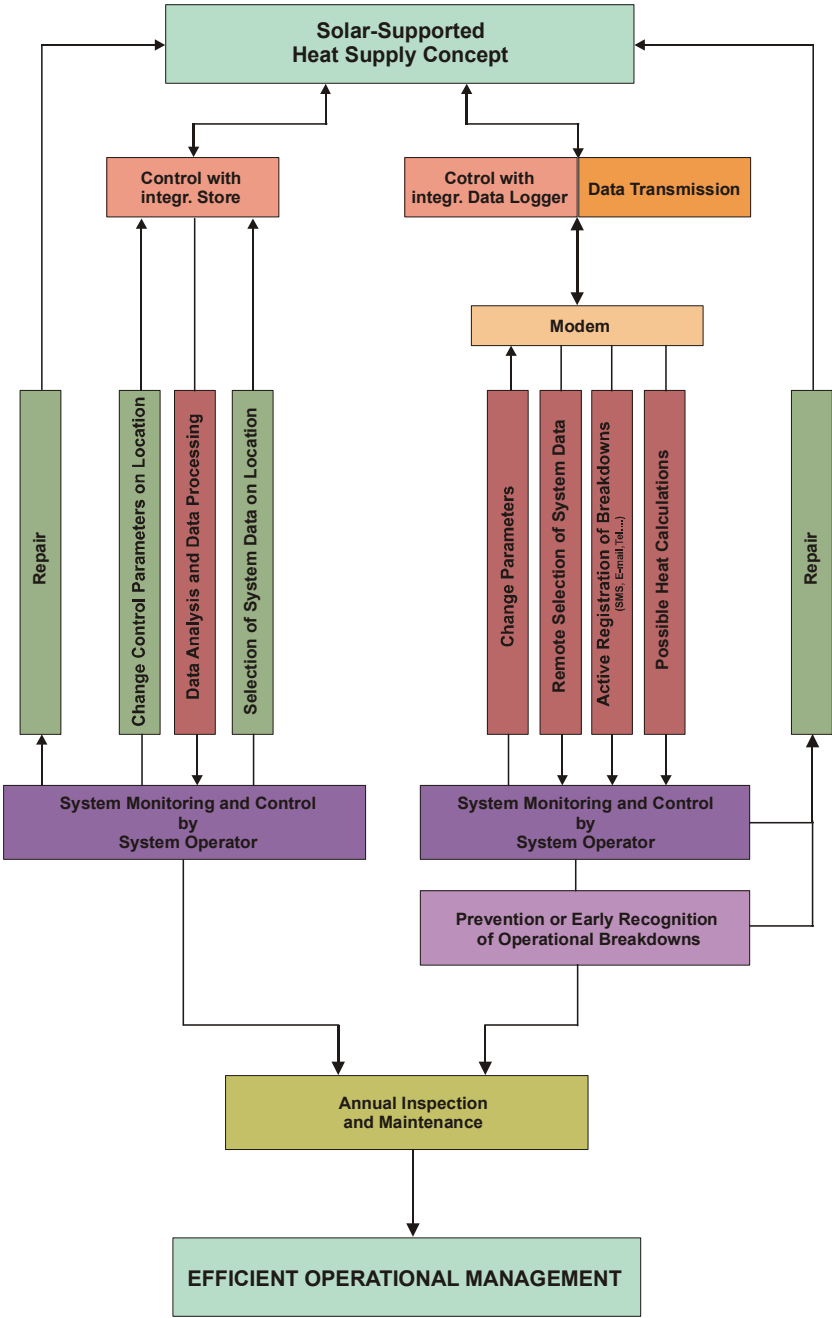

Figure 115: Illustration of the different regulation and monitoring possibilities for solar-supported heat supply concepts for multi-storey residential buildings.

List of references

DIN 4708, 1994

Zentrale Wassererwärmungsanlagen, Regeln zur Ermittlung des Wärmebedarfs zur Erwärmung von Trinkwasser in Wohngebäuden, Deutsches Institut für Normung e.V., Berlin, 1994

DVGW Arbeitsblatt W551 und W552, 1993

DVGW Arbeitsblatt W551 und W552 "Trinkwassererwärmungs- und Leitungsanlagen; Technische Massnahmen zur Verminderung des Legionellenwachstums", Deutscher Verein des Gas- und Wasserfaches e.V., Bonn, 1993

Faninger et al., 2003

Gerhard Faninger, Verband Austria Solar: Bericht "Der Solarmarkt in Österreich 2002", Universität Klagenfurt und Verband Austria Solar, Klagenfurt, 2003

Fernwärme Wien, 1998

Georg Kasik, Fernwärme Wien: Eine Untersuchung der Abteilung Forschung und Entwicklung zum Thema "Einbindung von Solaranlagen in die Warmwasserbereitung fernwärmeversorgter Objekte", Fernwärme Wien, 1998

Fink, Purkarthofer, 2000

Christian Fink, Gottfried Purkarthofer: Endbericht zum EU-Projekt "Garantierte Wärmelieferung aus thermischen Solaranlagen im Wohnbau", Contract N° 4.1030/Z97-014, **AEE INTEC**, Gleisdorf, 2000

Fink et al., 2002:

Christian Fink, Richard Riva, Richard Heimrath, Thomas Mach: Endbericht zum Projekt "Solarunterstützte Wärmenetze", Projektteil "Thermische Solaranlagen für Geschoßwohnbauten", **AEE INTEC** und Institut für Wärmetechnik an der TU – Graz, Gleisdorf, 2002

Fink et al., 2003:

Christian Fink, Werner Weiß: Endbericht zum Projekt "Strategien zur Erhöhung des Beitrages von solarthermischen Anlagen zur Erreichung des Kyoto-Ziels", **AEE INTEC**, Gleisdorf, 2003

Gassel, 1997

Andreas Gassel: PhD thesis "Beiträge zur Berechnung solarthermischer und exergieeffizienter Energiesysteme", Technische Universität Dresden, 1997

Hausner et al., 2003

Robert Hausner, Christian Fink, Waldemar Wagner, Richard Riva, Frank Hillerns: Endbericht zum Projekt "Entwicklung von thermischen Solarsystemen mit unproblematischem Stagnationsverhalten", **AEE INTEC** und Tyforop Chemie GmbH, Gleisdorf, 2003

Heimrath, 2004

Richard Heimrath: PhD thesis "Simulation, Optimierung und Vergleich solarthermischer Anlagen zur Raumwärmeversorgung für Mehrfamilienhäuser", Institut für Wärmetechnik an der TU – Graz, Graz, 2004

Jordan et al., 2001

Ulrike Jordan, Klaus Vajen: Influence of the DHW Load Profile on the Fractional Energy Savings: A Case Study of a Solar Combi-System with TRNSYS Simulation, pp. 197 - 208, Journal of the Int. Solar Energy Society, 2001

Klein et al., 2000

Klein, S.A., Beckman, W.A., TRNSYS – A Transient System Simulation Program Version 14.2, University of Wisconsin, Madison, USA

Logotherm, 2004

Produkt- und Planungsordner der Fa. Logotherm, Deutschland, Vertrieb in Österreich: Fa. Impex Handelsgesellschaft m.b.H, Wels, 2004

Luboschik et al., 1997

Ulrich Luboschik, Nenad Halagic: Endbericht zum Thermie Projekt "Guaranteed Results for Thermal Plants of Town Utilities in Germany", Contract N° SE/475/93/D, Germany, 1997

Meisl, 2003

Helmut Meisl: Broschüre der gswb Salzburg (Gemeinnützige Salzburger Wohnbaugesellschaft m.b.H.): Ganzheitliches Solarkonzept für den Wohnbau, Salzburg, 2003

Meteonorm, 1995:

Handbuch zum gleichnamigen Programm, METEOTEST, Fabrikstrasse 14, CH-3012 Bern, Switzerland, 1995

Müller et al., 2004

Thomas Müller, Robert Hausner, Irene Bergmann, Karl Höfler, Werner Nussmüller: Broschüre "Planungsrichtlinien für farbige Fassadenkollektoren" im Rahmen des Projektes "Coloured Collector Facades for Solar Heating Systems and Building Insulation" im Auftrag der Generaldirektion Forschung der Europäischen Kommission, **AEE INTEC**, TB Höfler und Architekturbüro Nussmüller, Gleisdorf, 2004

OIB, 1999

OIB, Österreichisches Institut für Bautechnik, Leitfaden für die Berechnung von Energiekennzahlen, 1999

ÖNORM EN 832, 1998

Wärmetechnisches Verhalten von Gebäuden – Berechnung des Heizenergiebedarfes – Wohngebäude, Österreichisches Normungsinstitut, 1998

ÖNORM EN 12831

Heizungsanlagen in Gebäuden; Verfahren zur Berechnung der Norm-Heizlast, Österreichisches Normungsinstitut, 2003

ÖNORM M 7580, 1985

Wärmedämmung von Heizungsanlagen, Österreichisches Normungsinstitut, 1985

POLYSUN, 2003

Computersimulation von thermischen Solaranlagen, Solarenergie Prüf- und Forschungsstelle, Oberseestraße 10, CH-8640 Rapperswil, Vertrieb in Österreich und Südtirol: Arbeitsgemeinschaft ERNEUERBARE ENERGIE GmbH, A-9500 Villach

Recknagel et al., 2003

Hermann Recknagel, Eberhard Sprenger, Ernst R. Schramek: Taschenbuch für Heizung und Klimatechnik, Munich, 2003

Redan, 2004

Product and planning list from Redan, Denmark, marketed in Austria by Inocal Wärmetechnik GmbH., Linz, 2004

Remmers, 1999

Karl-Heinz Remmers: Große Solaranlagen – Einstieg in Planung und Praxis, ISBN: 3-901626-16-60, Die Solarpraxis, Berlin, 1999

Schlader, 2002

W. Schlader: Endbericht zum Projekt "Solaranlagen Evaluation", Energieinstitut Vorarlberg, Vorarlberg, 2002

Stadler et al., 2002

Irene Stadler, Werner Weiß: Endbericht zum Projekt "Systemtechnische und bauphysikalische Grundlagen für die Fassadenintegration von thermischen Sonnenkollektoren ohne Hinterlüftung", **AEE INTEC**, Gleisdorf, 2002

Statistisches Jahrbuch, 1999

Statistisches Jahrbuch für die Republik Österreich 1999:2000, Verlag Österreich, ISBN 3-901400-17-6

TSOL, 2003

Ein Windows™-Programm zur Auslegung und Simulation thermischer Solaranlagen, Innovative Ingenieur Software, Dr.-Ing. Gerhard Valentin, Köpenicker Str. 9. D-10997 Berlin. Vertrieb in Österreich und Südtirol: Arbeitsgemeinschaft ERNEUERBARE ENERGIE GmbH, A-9500 Villach

VDI-Richtlinie 2067, 1999

Wirtschaftlichkeit gebäudetechnischer Anlagen, Grundlagen und Kostenrechnung, Verein Deutscher Ingenieure, 1999

Weiß, 2003

Werner Weiß, ed.: Solar Heating Systems for Houses – A Design Handbook for Solar Combisystems, produced within the framework of Task 26 of the IEA (International Energy Agency, Solar Heating and Cooling), ISBN 1-902916-46-8, published by James & James, 2003

Internet:

Campbell et al., 1998

Campbell C. J., Laherrere J.H.: The end of cheap oil: Scientific American, vol. 278, no. 3, pp. 78-83, <http://www.mindfully.org/Energy/Running-Out-Of-Oil.htm>, 1998

EVA, 2004

EVA, Energieverwertungsagentur, Übersicht über Landes-, Bundes- und EU-Förderungen für Thermische Solarenergie: [http://www.eva.ac.at/\(de\)/esf/index.htm#h1](http://www.eva.ac.at/(de)/esf/index.htm#h1), 2004

13

Index

A

Aesthetics 23, 32

Annual system utilisation rate S_{Nutz} 38

Average living space 18

Average number of occupants 19

B

Boiler	74
Building integration	23, 33
Building physics	30
Building renovation	62

C

Circulation bridge	55
Circulation line	20, 62
Circulation principle	55, 73
Coatings	32
Cold water	20
Cold water temperature	19
Collector area	66
Collector assembly	23
Collector circuit mounting	41, 47
Collector efficiency rate	9
Collector inclination	28, 72
Collector orientation	72
Collector pipework	42
Collector roof	24 - 25
Collector temperatures	8
Coloured absorber layers	32
Comfort	11
Concrete base	27 - 28
Condensate	31
Consumption measurement	19
Consumption profile	20

Cost groups 86

Crane assembly 24, 41

D

Daily consumption 17

Daily consumption profile 21

Differential pressure control device 55, 57

Diffusion radiation 14

Dimensioning nomogram 68, 70, 72

Dimensioning 47, 66

Domestic hot water mixer 20

Domestic hot water 17

Domestic water consumption 17

Domestic water storage tank 20, 60, 63

Domestic water temperature 35

E

Economic efficiency 84 - 85

Economic factor 5

Effective U-value 32

Elongation compensation 44

Emptying behaviour 47

Energy calculation 61

Energy efficiency 23

Energy insulation standard 13, 78

Energy quantity meter 20, 56

Energy requirements 16 - 17, 19, 21, 23, 25, 27, 29, 31, 33

Energy storage tank costs 86

Energy storage tank losses 16, 79

Energy storage tank 33
Error notifications 88
Existing buildings 53, 62

F

Façade integration 29
Faucet category 18
Faucet points 73
Flat roof 26
Fossil forms of energy 13
Four conductor networks 62
Frost protection switch 40

G

Global radiation 14
Grants 84 - 85
Gross collector area 37

H

Heat distribution network 57, 73, 77
Heat exchanger 55, 64
Heat generator 51
Heat losses 78 - 79, 81, 83
Heat supply concepts 7, 50
Heat transfer medium 50
Heat transfer units 53
Heating energy requirements 22
Heating load 23
High Flow 38

I

Inclination 72
Insulation of fittings 84
Insulation thickness 79, 82
Insulation 78
Integral planning 8
Interpretation of data 88
Investment costs 12, 84 - 85

K

Key figures 36

L

Large-scale collectors 41
Layer unloading 51
Legionella bacteria 11, 35
Length expansion 44
Load equalisation storage tank 74
Loading storage tank principle 59
Loading strategy 38, 51
Low Flow 38

M

Market penetration 5
Matched Flow 39
Mean collector temperatures 8
Measurement recording 19, 87
Measuring results 17, 58
Membrane expansion vessel 47
Mixing valve 57
Monitoring strategy 89

Multiple storage tank systems 80

N

Network temperature 57

O

On roof assembly 26

One storage tank systems 62

Operating costs 13

Orientation 72

Outside temperature 9, 22

Overheated steam 46

P

Parallel circuit 43

Peak load 17, 73

Person-related domestic hot water requirements 17

Pipe coats 83

Pipeline losses 16, 82

Pipework 82

Plant/system management 87, 89

Preparation of domestic water 55, 59

Pressure loss 39

Proportional control device 55

Pump 57

R

Radiation energy 14

Radiation performance 14

Regulation strategy 40, 89

Regulation 40, 88

Remote control monitoring 87
Renewable forms of energy 13
Return group arrangement 48
Return temperature limiter 56
Return temperature 9, 58

Rinsing 44

Roof integration 24

S

Safety of supply 73

Safety valve 50

Saturated steam 46

Series circuit /switching 43, 81

Shading 28

Simultaneity factor 74

Solar coverage rate SD 36

Solar market 5

Solar radiation 14 - 15

Solar storage tank volume 66, 70, 77

Solar system price 85

Space heating supply 55, 60, 64, 73

Specific mass flow 39

Specific solar yield SE 37

Speed control 40

Stagnation behaviour 45

Stagnation cooler 49

Standard structure 26

Standby storage tank 64, 76

Standby volume	76
Storage tank connections	52, 80
Summer coverage	67
Supply temperature	74
Switching volume	77
System filling pressure	50
System hydraulics	35, 37, 39, 41, 43, 45, 47, 49, 51, 53, 55, 57, 59, 61, 63, 65
System monitoring	87
System price	84
System utilisation rate	9, 38

T

Thermal insulation	33, 78
Thermosiphon	80
Thermostat valve	56
Two-pipe network	51, 58
Two storage tank systems	64

U

Useful effect	48
Utilisation	67

V

Ventilation	44
Vessel preliminary pressure	48

W

Hot water faucet quantity	21
Water hygiene	11, 35
Water meter	19, 56
Weather data sets	15

